

# DRIVER INFORMATION DISPLAY MANUAL



Volvo Trucks. Driving Success.®





---

# Contents

<b>Driver Information Display</b> .....	1
<b>STALK SWITCH CONTROL LEVER</b> .....	1
Stalk Switch Functions .....	2
Selecting a Menu .....	2
Changing Settings .....	4
<b>BASIC LEVEL INSTRUMENT CLUSTER DID</b> .....	5
Digital Gauges .....	7
1. Outside Temperature .....	7
2. Distance to Destination .....	7
Display Settings .....	7
1. Contrast .....	7
2. Backlight .....	7
Time/Date .....	7
Setup .....	8
1. Language .....	8
2. Distance .....	8
3. Temperature .....	8
Aftertreatment .....	9
<b>MID-LEVEL AND HIGH-LEVEL INSTRUMENT CLUSTER</b>	
<b>DID</b> .....	14
Mid-Level and High-Level DID Menus .....	16
Driving Menus .....	16
Digital Gauges in the DID (High and Mid Level Cluster Only) .	17
1. Current Gear Position (Automated Transmission) .....	18
2. Outside Temperature .....	19
3. Engine Oil Temperature .....	20
4. Transmission Oil Temperature .....	21
5. Battery Voltage .....	22
6. Front and Rear Axle Temperature .....	23
7. Front and Rear Suspension Pressure .....	24
8. Volvo Link Compass .....	25
Fuel Data .....	25
1. Instantaneous Gallons Per hour .....	26
2. Trip Fuel Used .....	27
3. Distance to Empty .....	28
4. Fuel Economy .....	29

---

5. Idle Percent .....	30
6. Sweet Spot/Performance Bonus .....	31
7. Sweet Spot Percentage .....	32
8. Road Speed Limit .....	33
Time/Distance .....	34
1. Time and Date .....	34
2. Alarm Clock .....	35
3. Distance to Destination .....	36
4. Trip Average Speed .....	37
5. Estimated Time of Arrival (ETA) .....	38
Aftertreatment .....	39
Aftertreatment Status .....	40
Volvo Link .....	48
Display .....	49
1. Black Panel .....	49
2. Favorite Display .....	50
3. Backlight .....	51
4. Favorite Display Setting .....	52
5. Night/Day .....	52
Vehicle Messages .....	52
Reset .....	55
Non-Driving/Stationary Menu .....	56
Display Setting .....	59
1. Language .....	60
2. Units .....	61
4. Display Light .....	63
5. Change Password .....	65
Vehicle Settings .....	66
1. Fleet Limits .....	66
2. Fleet ID .....	70
3. Drain Water in Fuel (if equipped) .....	71
Diagnostics .....	71
1. Fault Diagnostics .....	72
2. Cluster Self Test .....	72
3. Part Number .....	73
Vehicle Data .....	76
1. Oil Level (Volvo engines only) .....	76
2. Maintenance Data .....	77

---

Datalog .....	78
1. Vehicle ID .....	78
2. Sweet Spot Data .....	80
3. Total Data .....	81
4. Trip Data .....	82
5. Reset Trip Data .....	87
Pre-Trip Assistance .....	89
Volvo Enhanced Cruise (VEC) .....	97
Tire Pressure System .....	101
Password .....	101
1. Password .....	101
DISPLAY SYMBOLS .....	104
Alarm, Check and Information Symbols .....	104
STATUS SYMBOLS .....	109
Other Symbols .....	110
MESSAGES .....	111
General .....	111
Stop Message .....	111
Warning Message .....	112
Information Message .....	113
Stop, Check, Info Symbols and Associated Icons .....	114
Acknowledging Messages .....	116
Examples of Fault Symbols and Text .....	116

---

---

# Safety Information

**IMPORTANT:** Before driving this vehicle, be certain that you have read and that you fully understand each and every step of the driving and handling information in this manual. Be certain that you fully understand and follow all safety warnings.

IT IS IMPORTANT THAT THE FOLLOWING INFORMATION BE READ, UNDERSTOOD AND ALWAYS FOLLOWED.

The following types of advisories are used throughout this manual:



## DANGER

Danger indicates an unsafe practice that could result in serious personal injury or death. A danger advisory banner is in **white** type on a **black** background with a **black** border.



## WARNING

Warning indicates an unsafe practice that could result in personal injury. A warning advisory banner is in **black** type on a **gray** background with a **black** border.



## CAUTION

Caution indicates an unsafe practice that could result in damage to the product. A caution advisory is in **black** type on a **white** background with a **black** border.

**Note:** Note indicates a procedure, practice, or condition that must be followed in order for the vehicle or component to function in the manner intended.

**Labels** Danger, Warning, Caution and Advisory labels are placed in various locations of the vehicle to alert drivers and service technicians about situations that may lead to personal injury or equipment damage. In the event that a label is damaged or missing the **label must be replaced**. Contact your authorized Volvo Truck dealer for assistance regarding labels.

---



## STALK SWITCH CONTROL LEVER

The stalk switch control lever is used to interact with the DID. The lever is located on the right-hand side of the steering wheel.

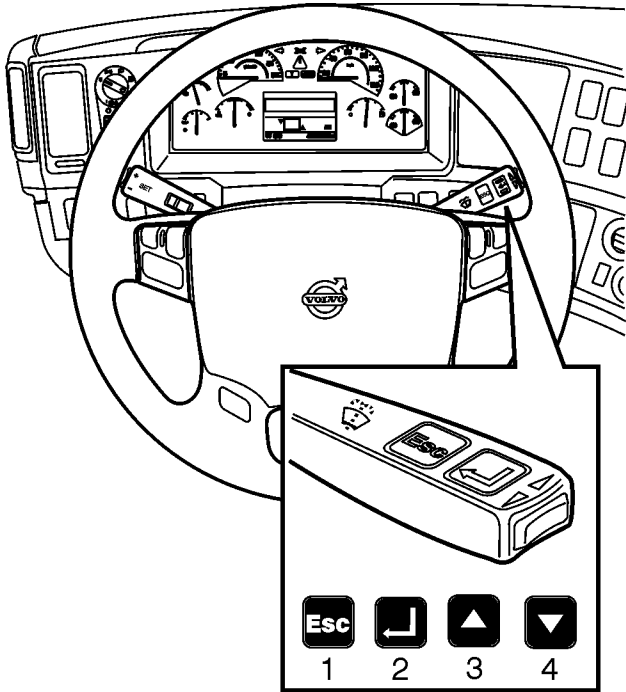

W3005262

## 2 Driver Information Display

---

### Stalk Switch Functions

- The Esc or Escape button is used to return to the previous menu or display, or to cancel a setting or operation.
- The Enter button is used to display a list of menus, open a menu, and select a chosen value.
- The Up arrow is used to scroll up through a menu and to increase numerical values.
- The Down arrow is used to scroll down through a menu and to decrease numerical values.

### Selecting a Menu

The following drawing is the current condition screen. This is what is displayed when starting the truck and also while driving.

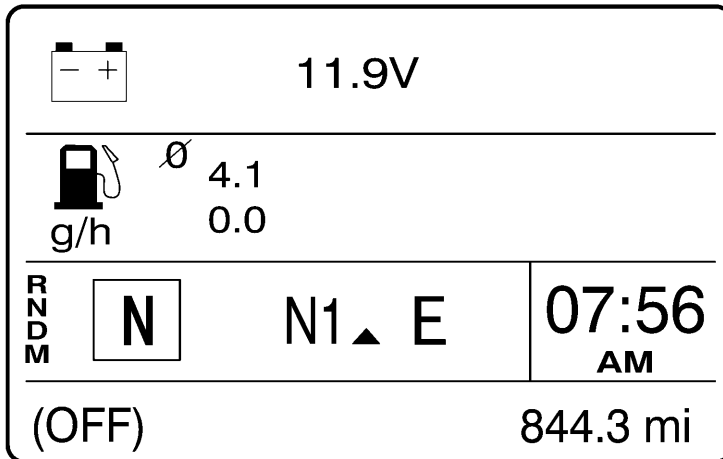

- 1 Press the Enter button to display the available menus.
- 2 Use the up and down arrows to scroll through the list of menus.
- 3 Press the Enter button to open the selected menu.
- 4 Press the Esc button to return to the previous menu or display, or to cancel a setting or operation.

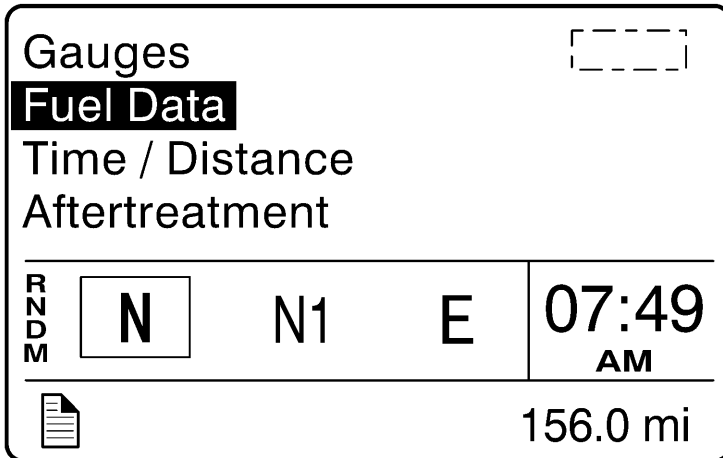

## 4 Driver Information Display

---

### Changing Settings

- 1 The up and down arrows increase and decrease set values.
- 2 Press the Enter button to confirm the choice and move to the next position.
- 3 Press the Esc button to return to the previous position, or to cancel a setting or operation.

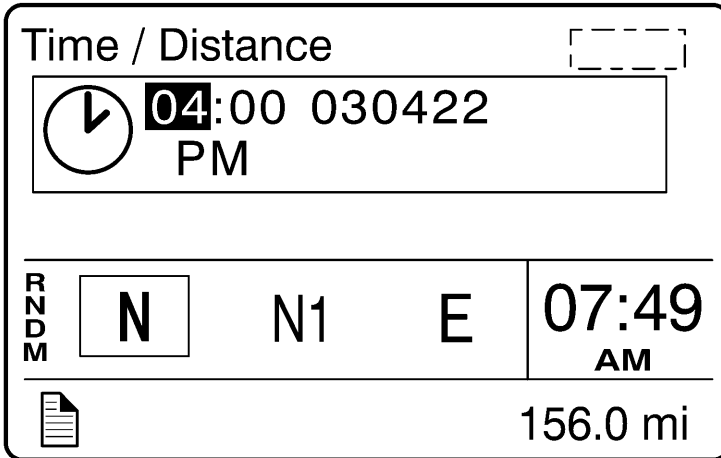

## BASIC LEVEL INSTRUMENT CLUSTER DID

The basic Driver Information Display (DID) is located in the center of the basic level instrument cluster. The DID displays digital gauges, main menus and sub-menus that provide necessary and important information to the vehicle operator. The information available to the operator depends on vehicle configuration.

There are two sections of display information in the basic DID:

- Top — Menus and gauges
- Bottom — Odometer

The default display is clock and odometer. Press the Enter button to display the menu.



W3029664

- 1 Menus and gauges
- 2 Odometer

## 6 Driver Information Display

---

**Note:** Depending on vehicle configuration, some menus may not be available.

The following menus are available with the basic DID.

- Digital Gauges
  - Outside Temperature
  - Distance to Destination
- Display Settings
  - Contrast
  - Backlight
- Time/Date
- Aftertreatment
  - Initiate REGEN
  - ATS Status
  - Cancel REGEN
- Setup
  - Language
  - Distance
  - Temperature

## Digital Gauges

### 1. Outside Temperature

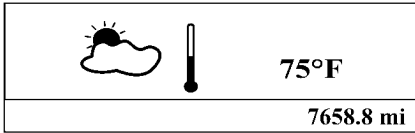

W3029666

### 2. Distance to Destination



W3029667

## Display Settings

### 1. Contrast

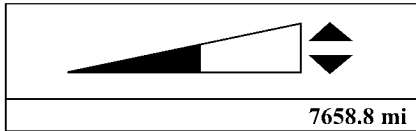

W3029668

### 2. Backlight

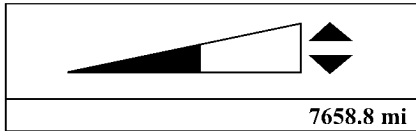

W3029669

## Time/Date

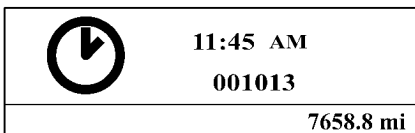

W3029670

# 8 Driver Information Display

---

## Setup

### 1. Language

<input checked="" type="checkbox"/> English
<input type="checkbox"/> Espanol
<input type="checkbox"/> Francais
7658.8 mi

W3029671

### 2. Distance

<input type="checkbox"/> km
<input checked="" type="checkbox"/> mi
7658.8 mi

W3029672

### 3. Temperature

<input checked="" type="checkbox"/> °C
<input type="checkbox"/> °F
7658.8 mi

W3029673



## Aftertreatment

The Aftertreatment status submenus provide information about the conditions required for performing a regeneration. The status can be OK (regeneration allowed), CHECK (regeneration not allowed) or N/A (not applicable). When ATS Status is selected, the following submenus are available.

<b>Clutch</b>	<b>OK</b>	<b>▲</b>
<b>Service Brake</b>	<b>OK</b>	
<b>PTO Status</b>	<b>OK</b>	<b>▼</b>
<hr/>		
<b>7721.4 mi</b>		

W3007450

To perform a parked regeneration, the clutch pedal must not be depressed, the service brake must not be engaged and a PTO must not be engaged or the PTO must be able to operate above the minimum engine speed required.

## 10 Driver Information Display

---

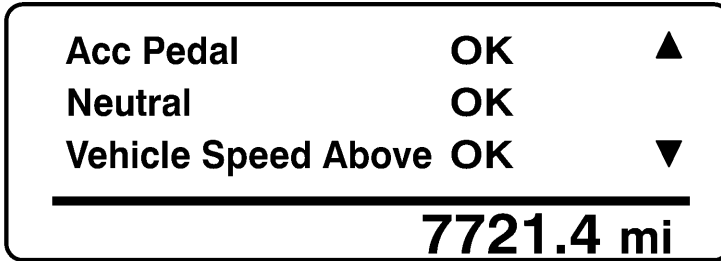

W3007449

To perform a parked regeneration, the accelerator pedal must not be depressed, the transmission must be in the neutral position and the vehicle speed must not be above zero.

<b>Park Brake</b>	<b>OK</b>	<b>▲</b>
<b>System Fault</b>	<b>OK</b>	
<b>System Timeout</b>	<b>OK</b>	<b>▼</b>

---

**7721.4 mi**

W3007448

To perform a parked regeneration, the park brake must be engaged and there can be no active fault codes. The system will time-out if the duty cycle is inadequate to support an automatic regeneration or if there is a problem that is preventing regeneration. Attempt to perform a parked regeneration or take the vehicle to a Volvo Truck dealer for a service regeneration.

## 12 Driver Information Display

---

Temporary Lockout	OK	▲
Permanent Lockout	OK	
Engine Temp	OK	▼
<hr/>		
7721.4 mi		

W3007447

Temporary lockout prevents performing a regeneration when a regeneration is not needed. Permanent lockout prevents performing a regeneration when a condition exists that requires vehicle service. Take the vehicle to a Volvo Truck dealer. A minimum engine temperature of 35°C (95°F) is required for regeneration.

<b>Exhaust Temp</b>	<b>OK</b>	<b>▲</b>
<b>Vehicle Speed Below</b>	<b>OK</b>	
<b>Inhibit Switch</b>	<b>OK</b>	<b>▼</b>

---

**7721.4 mi**

W3007446

A minimum exhaust temperature of 250°C (482°F) is required for regeneration. The minimum vehicle speed for an automatic regeneration is 40 km/h (25 mph). When Disable REGEN is selected in the Cancel REGEN submenu, regeneration is inhibited. Select Enable REGEN to allow regeneration.

### MID-LEVEL AND HIGH-LEVEL INSTRUMENT CLUSTER DID

**Note:** Depending on vehicle configuration, some menus may not be available.

The Driver Information Display (DID) is located in the center of the mid-level and high-level instrument clusters. It displays digital gauges, main menus and sub-menus that provide necessary and important information to the vehicle operator.

The information available to the operator depends on vehicle configuration, and whether the vehicle is in operation or parked. Certain functions are password-protected and are not shown until the correct password is entered. See “Password” page 101.

There are three sections of display information in the DID:

- Top — Messages and available menus
- Middle — Favorite display
- Bottom — Current status and odometer

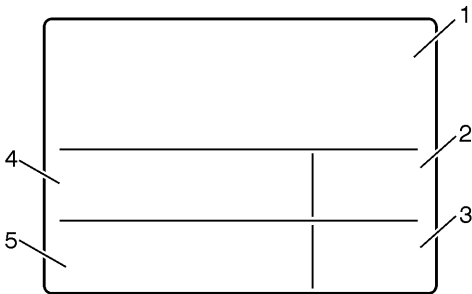

W3005515

- 1 Messages and Available Menus
- 2 Clock
- 3 Odometer
- 4 Favorite Display
- 5 Current Status

The top section displays messages, selected digital gauges, and the available DID menus. The favorite display, clock, odometer and current status are always visible. The current status section provides status information required at all times.

DID, example screen view:

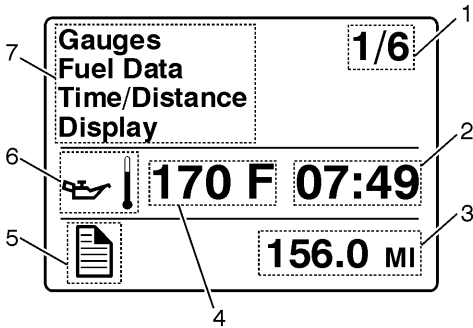

W3005172

- 1 Indicates First of Six Available Menus (varies by menu)
- 2 Clock
- 3 Odometer
- 4 Favorite Display
- 5 Current Status Icon(s)
- 6 Oil Temperature
- 7 Messages and Available Menus

### Mid-Level and High-Level DID Menus

There are Driving and Non-Driving menus. Several sub-menus are password-protected while the vehicle is parked. The Non-Driving menu is accessible only when the vehicle is parked.

#### Driving Menus

- Gauges
  - Current Gear Position (Automated Transmission)
  - Outside Temperature
  - Temperature Engine Oil
  - Temperature Transmission
  - Battery Voltage
  - Axle Temperature (Front/Rear)
  - Air Suspension (Front/Rear)
  - Volvo Link Compass
- Fuel Data
  - Instantaneous Gallons per Hour
  - Trip Fuel Used
  - Distance to Empty
  - Fuel Economy
  - Idle Percent
  - Sweet Spot/Performance Bonus
  - Sweet Spot Percentage
  - Road Speed Limit
- Time/Distance
  - Time and Date
  - Alarm Clock
  - Distance to Destination
  - Average Trip Speed
  - Estimated Time of Arrival (ETA)
- Aftertreatment
  - Request Parked REGEN
  - ATS Status
  - Delay REGEN
  - Cancel REGEN



- Volvo Link
  - Read Message
  - Send Message
  - Other Info
- Display
  - Black Panel
  - Favorite Display
  - Backlight
  - Favorite Display Setting
  - Night/Day
- Vehicle Messages
- Aftertreatment

## **Digital Gauges in the DID (High and Mid Level Cluster Only)**

There are several gauges in the Gauges menu. The number of gauges your vehicle is programmed with depends on the equipment level of the vehicle. The gauges are used to view current status of important functions in the vehicle.

All gauges are programmed into the instrument cluster and are therefore visible only in the DID.

- Current Gear Position (Automated Transmission)
- Outside Temperature
- Engine Oil Temperature
- Transmission Temperature
- Battery Voltage
- Front and Rear Axle Temperature
- Front and Rear Suspension Pressure
- Volvo Link Compass

# 18 Driver Information Display

---

## 1. Current Gear Position (Automated Transmission)

**Note:** When the vehicle is equipped with an automated transmission, the current transmission gear position is always displayed in the favorites display section.

The current gear position gauge is standard with automated transmissions.

- N = Neutral
- R = Reverse
- Forward Gear = 1 – 18 (varies with type of transmission)

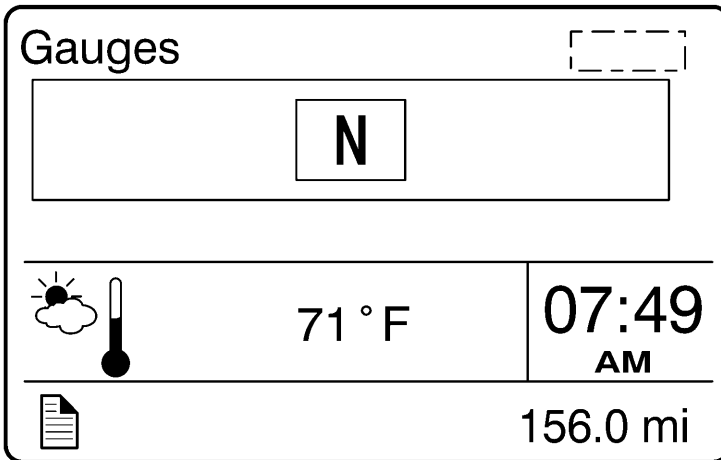

## 2. Outside Temperature

The outside temperature gauge is optional.

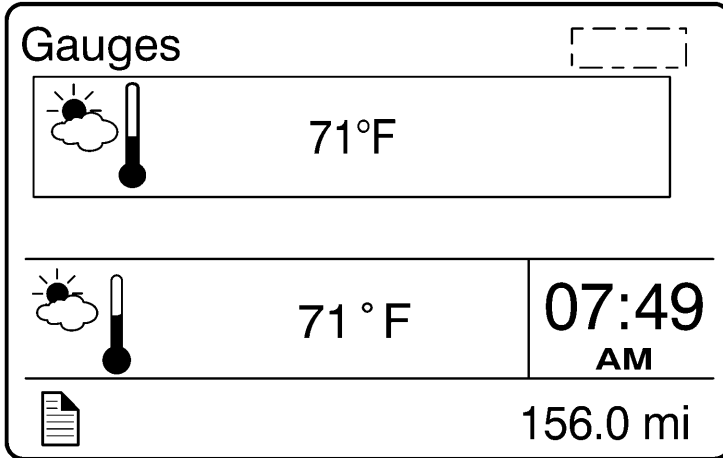

## 20 Driver Information Display

---

### 3. Engine Oil Temperature

The engine oil temperature is displayed as illustrated

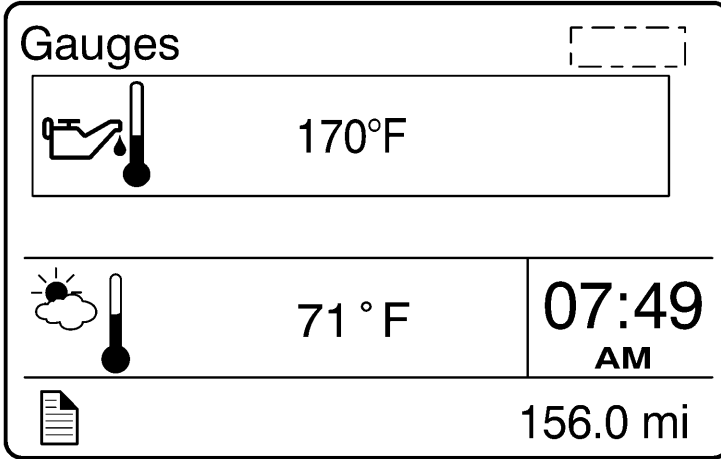

W3007428

#### 4. Transmission Oil Temperature

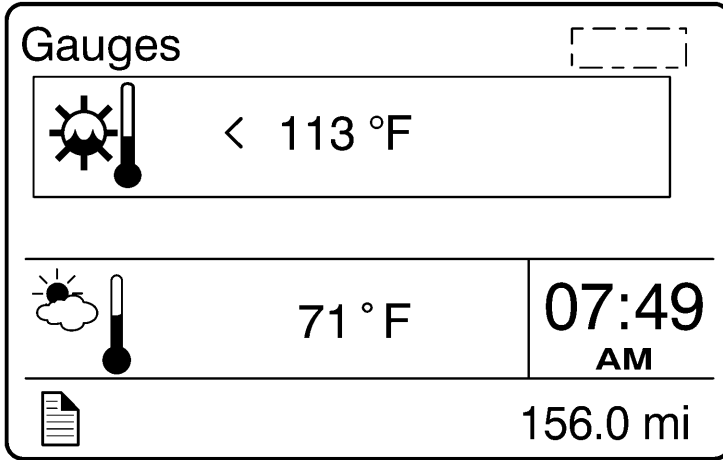

## 5. Battery Voltage

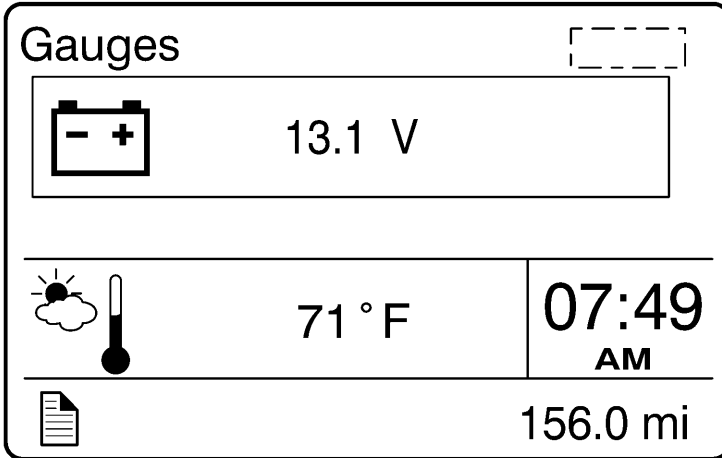

6. Front and Rear Axle Temperature

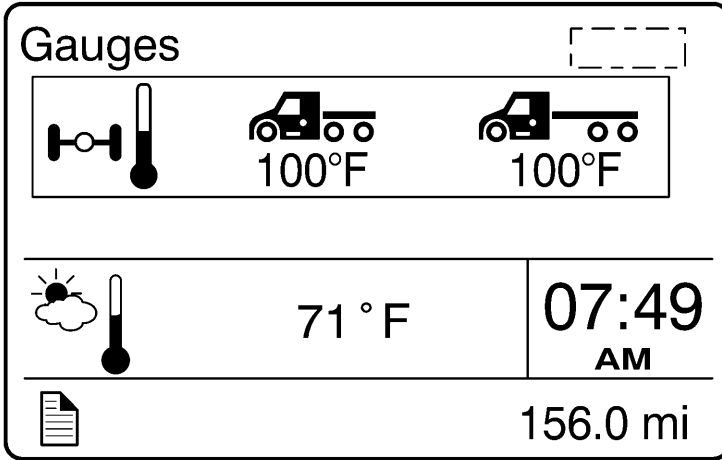

# 24 Driver Information Display

## 7. Front and Rear Suspension Pressure

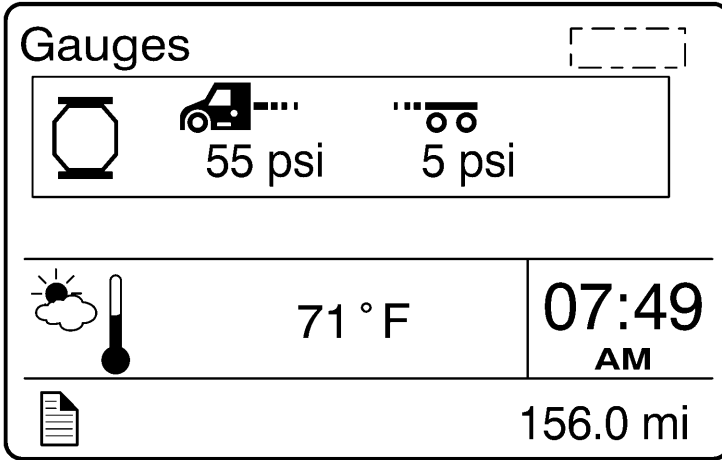



## 8. Volvo Link Compass

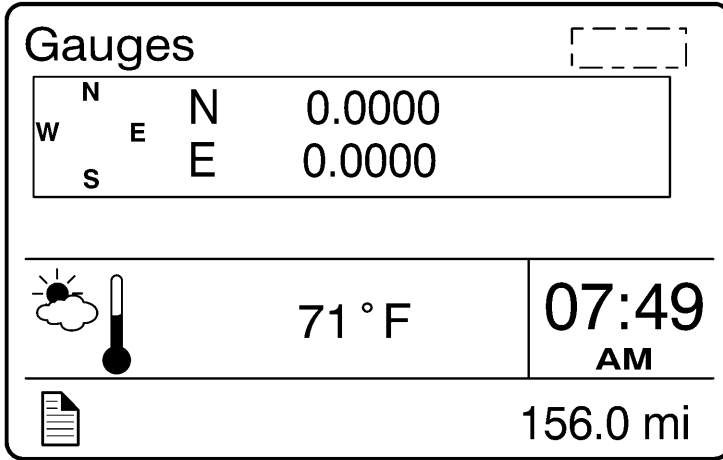

W3007423

## Fuel Data

The Fuel Data menu provides information on the fuel consumption of the vehicle in various situations. For example, how much fuel has been used, how much fuel is remaining, how much fuel is remaining before refueling the vehicle.

- Instantaneous Gallons Per Hour
- Trip Fuel Used
- Distance to Empty
- Fuel Economy
- Idle Percent
- Sweet Spot/Performance Bonus
- Sweet Spot Percentage
- Road Speed Limit

# 26 Driver Information Display

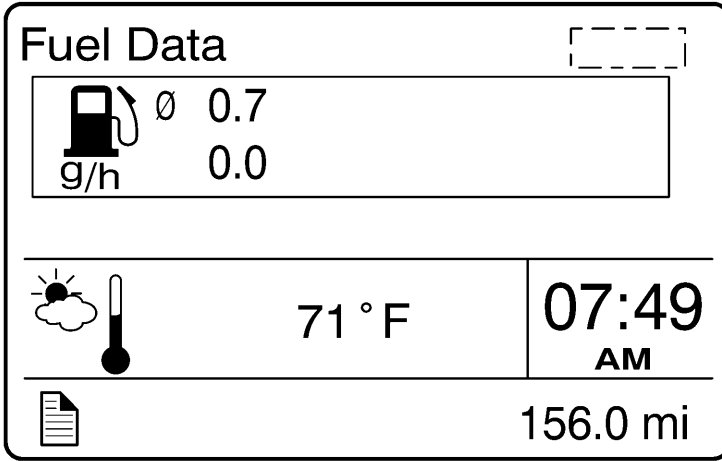

---

## 1. Instantaneous Gallons Per hour

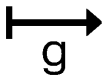

2. Trip Fuel Used

Fuel Data [ ]



 g	2692.2 g
 71 °F	07:49 AM
	156.0 mi

# 28 Driver Information Display

---

## 3. Distance to Empty

Fuel Data [ ]

	 → Empty
1771 mi	13 g

---

	71 °F	07:49 AM
---	-------	-------------

---

	156.0 mi
---	----------

4. Fuel Economy

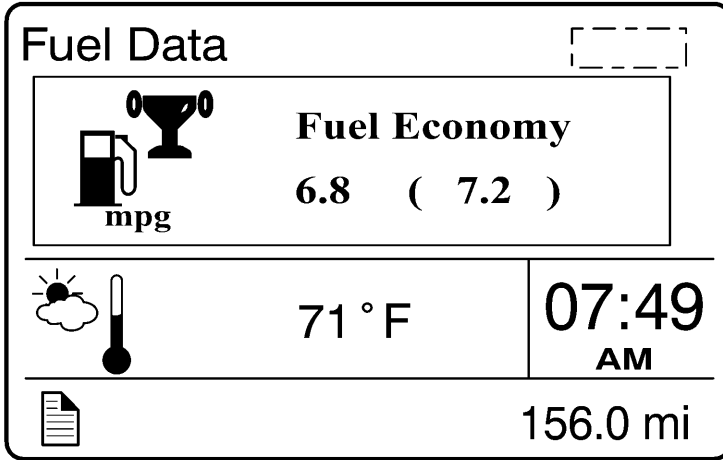



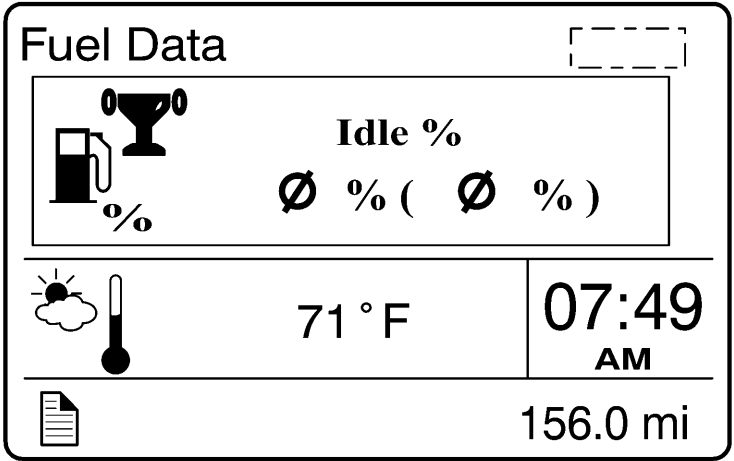



## 5. Idle Percent



### 6. Sweet Spot/Performance Bonus

**Note:** For information about sweet spot data, refer to Performance Bonus Guide in the vehicle operator's manual.

Fuel Data		[ ]
 ( 7.2)	 ( 25)	 (80)
6.8	16	66
 	71 °F	07:49 AM
	156.0 mi	

## 7. Sweet Spot Percentage

**Note:** For information about sweet spot data, refer to Performance Bonus Guide in the vehicle operator's manual.

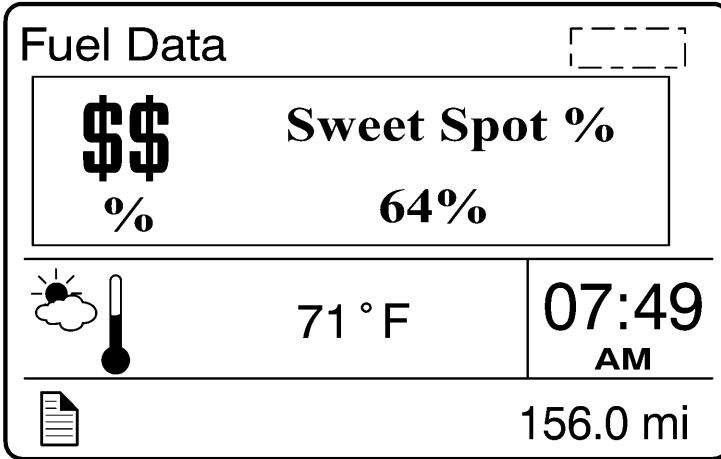



8. Road Speed Limit

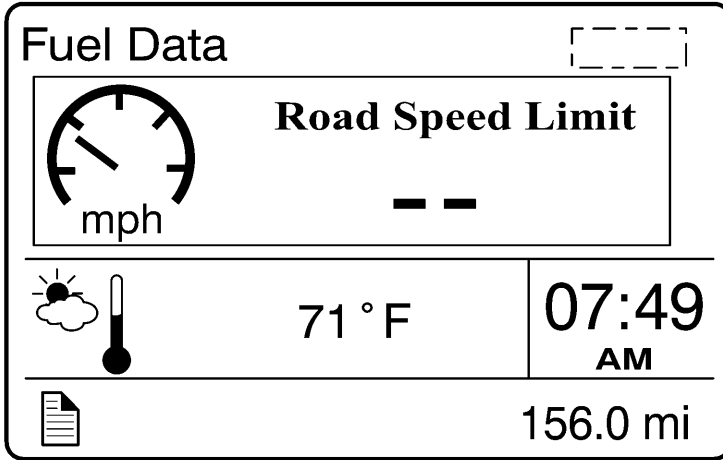

# 34 Driver Information Display

---

## Time/Distance



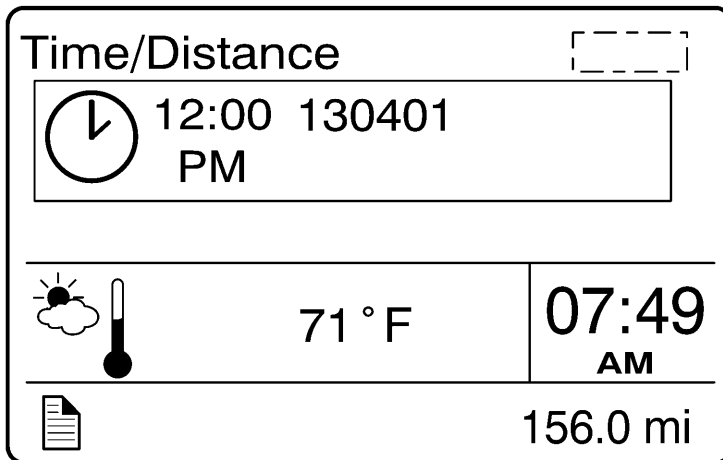

The time and date can be set in the Time/Distance menu. The alarm clock can also be set from this menu. Following the alarm clock menu is the Distance to Destination selection, which allows the operator see the distance since the last reset. Average trip speed is also shown. By specifying the distance to your destination, the vehicle can calculate the estimated time of arrival (ETA).

- Time and Date
- Alarm Clock
- Distance to Destination
- Average Trip Speed
- Estimated Time of Arrival (ETA)

### 1. Time and Date

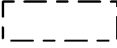

2. Alarm Clock

Time/Distance		
	12:00 PM	OFF
	71 °F	07:49 AM
	156.0 mi	

# 36 Driver Information Display

---

## 3. Distance to Destination

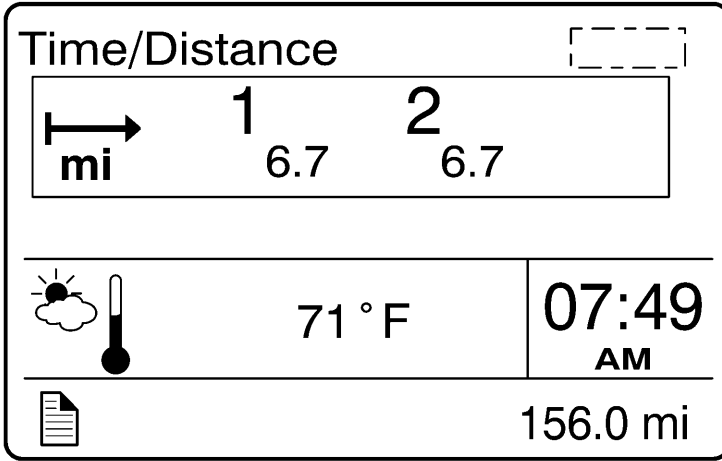



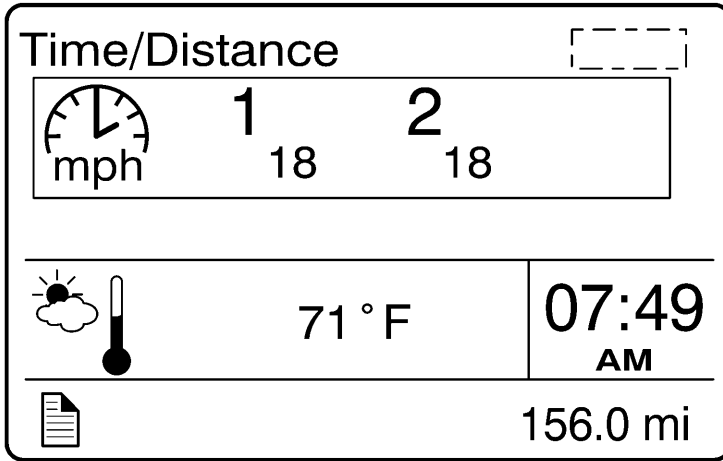

4. Trip Average Speed

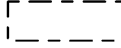

# 38 Driver Information Display

---

## 5. Estimated Time of Arrival (ETA)

Time/Distance		
	12:11 PM	0 mi
	71 °F	07:49 AM
	156.0 mi	

## Aftertreatment

**Note:** For additional information about the aftertreatment system, refer to the vehicle operator's manual.



The Aftertreatment menu allows the operator to request a parked regeneration, check the status of the aftertreatment system, and cancel a regeneration.

### Aftertreatment

Request Parked REGEN

ATS Status

Cancel REGEN

	<p style="font-size: 24px; margin: 0;">71 °F</p>	<p style="font-size: 36px; margin: 0;">07:49</p> <p style="margin: 0;">AM</p>
	<p style="font-size: 24px; margin: 0;">156.0 mi</p>	



## Aftertreatment Status

The Aftertreatment status submenus provide information about the conditions required for performing a regeneration. The status can be OK (regeneration allowed), CHECK (regeneration not allowed) or N/A (not applicable). When ATS Status is selected, the following submenus are available.

### ATS Status

Clutch	OK	▲
Service Brake	OK	▼
PTO Status	OK	▼

---

71 °F

07:49  
AM



---

156.0 mi

W3007435

To perform a parked regeneration, the clutch pedal must not be depressed, the service brake must not be engaged and a PTO must not be engaged or the PTO must be able to operate above the minimum engine speed required.



ATS Status		
ACC Pedal	OK	▲
Neutral	OK	
Vehicle Speed Above	OK	▼
 	71 °F	07:49 AM
	156.0 mi	

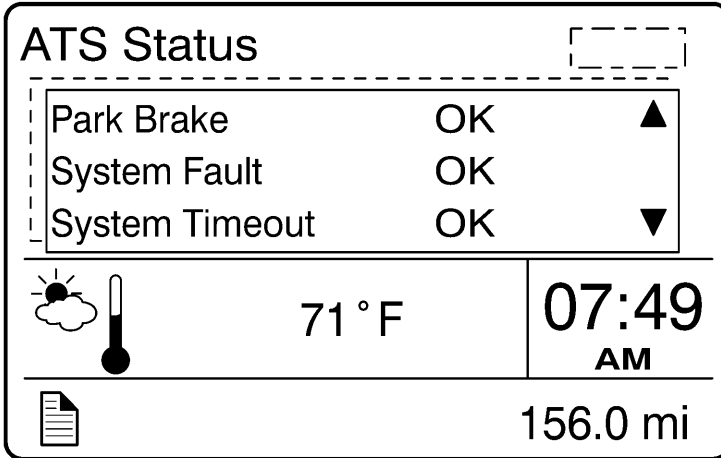

W3007434

To perform a parked regeneration, the accelerator pedal must not be depressed, the transmission must be in the neutral position and the vehicle speed must not be above zero.



W3007433

To perform a parked regeneration, the park brake must be engaged and there can be no active fault codes. The system will time-out if the duty cycle is inadequate to support an automatic regeneration or if there is a problem that is preventing regeneration. Attempt to perform a parked regeneration or take the vehicle to a Volvo Truck dealer for a service regeneration.

ATS Status		
Temporary Lockout	OK	▲
Permanent Lockout	OK	
Engine Temp	OK	▼
 	71 °F	07:49 AM
	156.0 mi	

W3007432

Temporary lockout prevents performing a regeneration when a regeneration is not needed. Permanent lockout prevents performing a regeneration when a condition exists that requires vehicle service. Take the vehicle to a Volvo Truck dealer. A minimum engine temperature of 35°C (95°F) is required for regeneration.

## ATS Status

Exhaust Temp	OK	▲
Vehicle Speed Below	OK	
Inhibit Switch	OK	▼

---

71 °F07:49  
AM

---

156.0 mi

W3007431

A minimum exhaust temperature of 250°C (482°F) is required for regeneration. The minimum vehicle speed for an automatic regeneration is 40 km/h (25 mph). When Disable REGEN is selected in the Cancel REGEN submenu, regeneration is inhibited. Select Enable REGEN to allow regeneration.

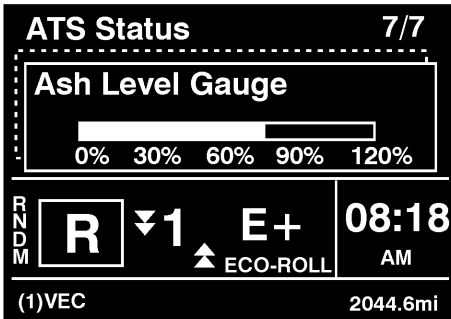

W3030053

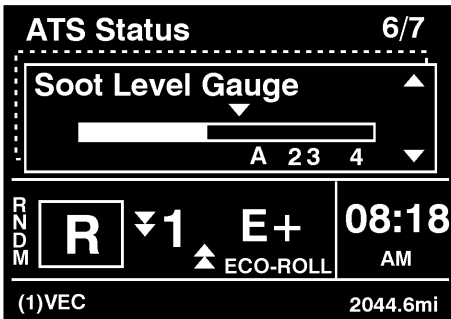

W3030054

From the ATS Status submenu, you can view both the Ash and Soot levels for the Aftertreatment system.

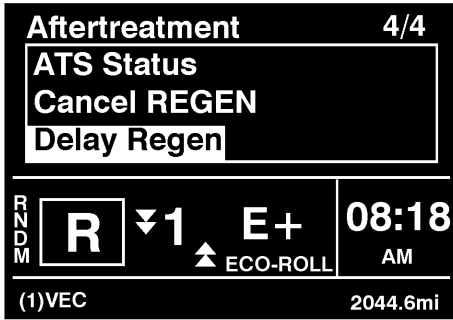

W3030055

From the Aftertreatment main menu, you can either cancel or delay a REGEN cycle.

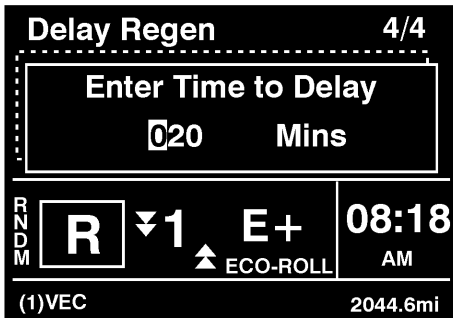

W3030056

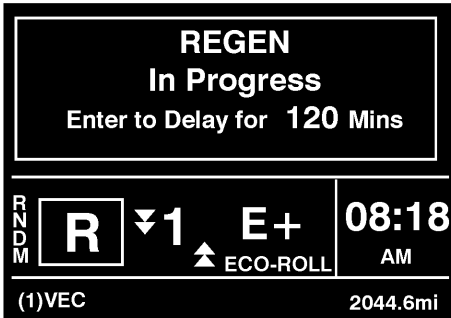

From the Delay REGEN submenu, you can set the amount of time to delay the REGEN cycle.



W3030057

After the delay is set, and the REGEN process starts, the **REGEN In Progress** screen displays.

## Volvo Link

<b>Fuel Data</b> <b>Time / Distance</b> <b>Aftertreatment</b> <b>Volvo Link</b>		
	N 36.0811 W 79.9688	<b>11:45</b> AM
		7658.8 mi

W3007688

Main Menu

<b>Volvo Link</b> Read Message Send Message Other Info		
	N 36.0811 W 79.9688	<b>11:45</b> AM
<b>CC</b>		7658.8 mi

W3007689

Start-Up Menu

For information about the Volvo Link System, refer to the Volvo Link System Operator's Manual.



## Display

The operator can adjust the display in the Display menu. The entire display can be blacked out for night driving. The display brightness level is adjustable. The Favorite Display function allows the operator to select up to three different gauges to be displayed at the same time. Night/Day can be selected to provide a light or dark background.

- Black Panel
- Favorite Display
- Backlight
- Favorite Display Setting
- Night/Day

### 1. Black Panel

The screen and the entire display is completely dark, except the speedometer and tachometer. The black panel mode can be exited by pressing the Esc button.

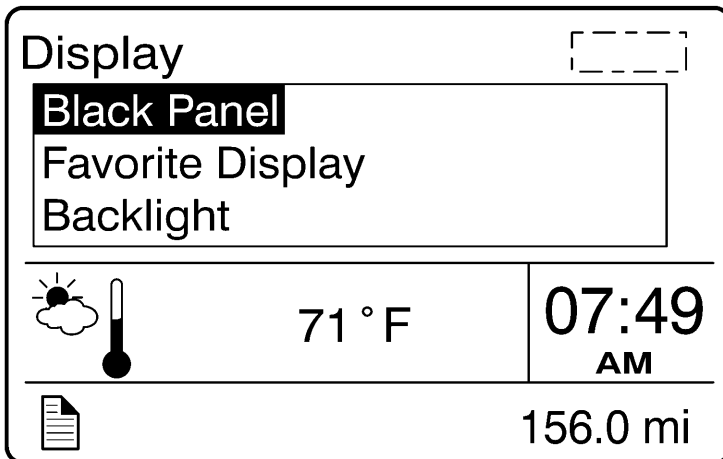

## 2. Favorite Display

**Note:** This section is for viewing your selection only. To choose your favorite selection, go to Favorite Display Setting (see “4. Favorite Display Setting” page 52).

If Favorite Display is selected, the DID will always display the selected gauges.

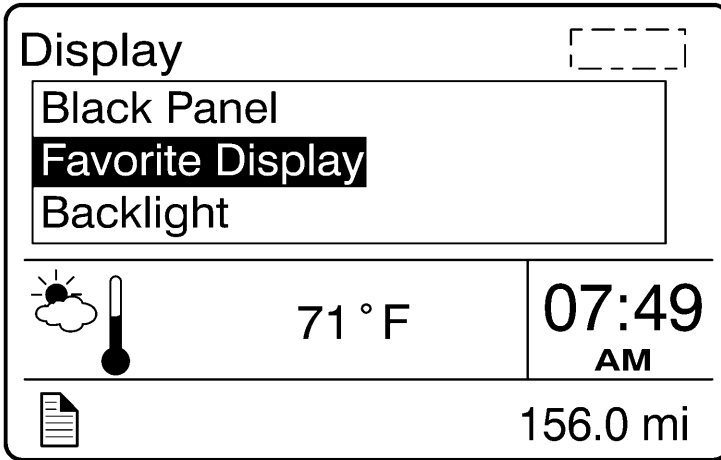

### 3. Backlight

To increase or decrease the backlight setting, press the up and down arrows on the stalk switch.

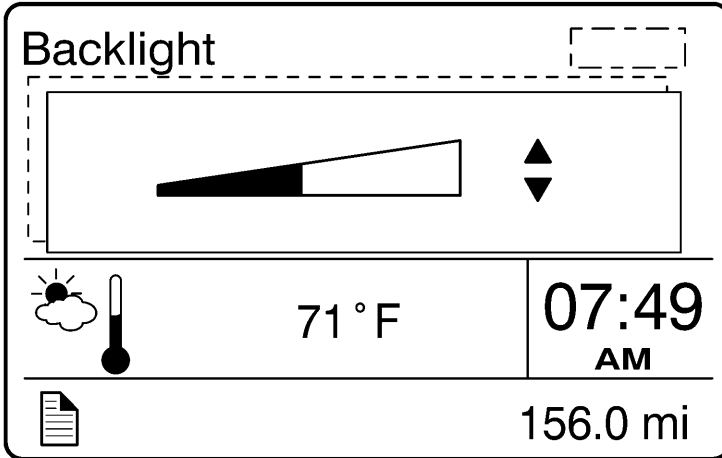

## 52 Driver Information Display

---

### 4. Favorite Display Setting

Select Favorite Display Setting to choose the gauges displayed on the DID.

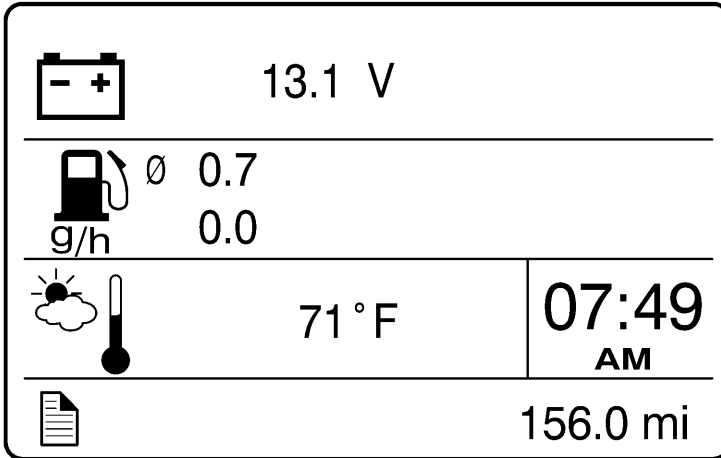

W3007406

### 5. Night/Day

Use the Night/Day menu to choose a dark background with light text and images or a light background with dark text and images.

### Vehicle Messages

Vehicle Messages appear in the DID depending on the number of faults the vehicle has at any given time.

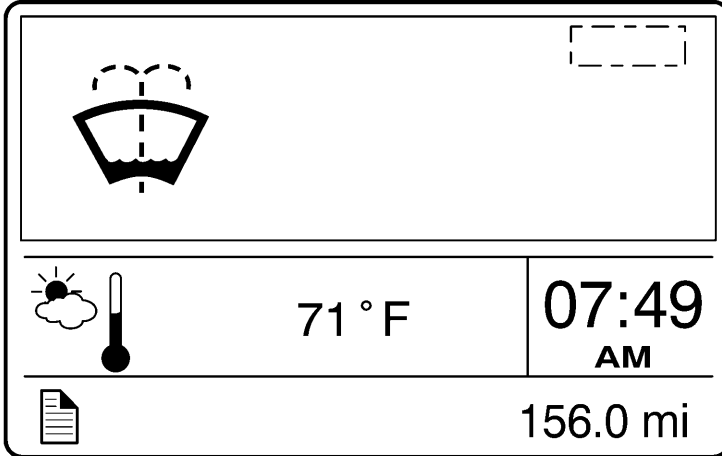

W3007405

Windshield Washer Fluid Low  
Message

If there are no messages, the following screen is displayed.

# 54 Driver Information Display

---

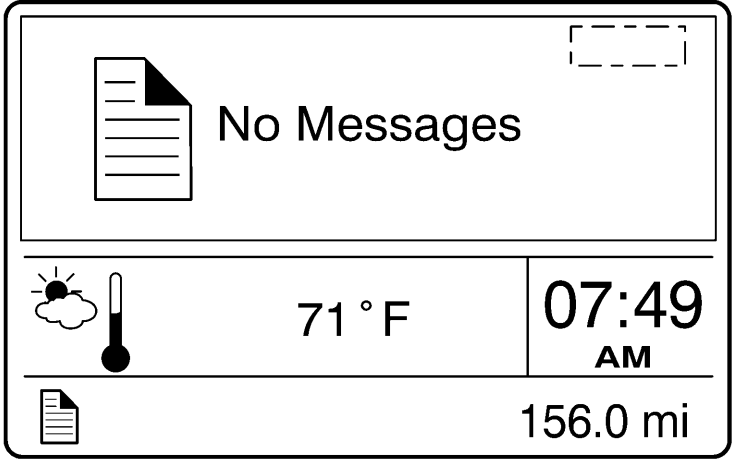

W3007404

## Reset

When the Reset menu is open, pressing and holding down the Enter button for more than 1 second resets the following functions:

- Instantaneous gallons per hour
- Trip fuel used
- Distance to empty

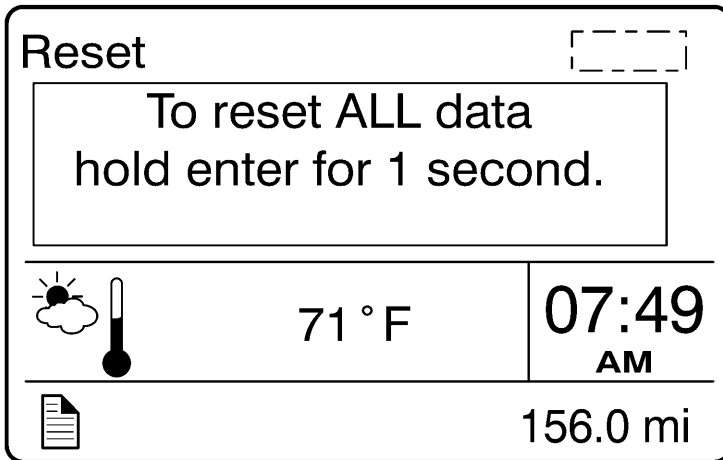

Non-Driving/Stationary Menu

**Display Settings**

Vehicle Settings

Diagnostics

Vehicle Data

Datalog

Tire Pressure System

Password



156.0 mi



- Display Setting
  - Language
  - Units
  - Time/Date
  - Display Light
  - Change Password
- Vehicle Settings (Volvo engines only)
  - Fleet Limits
  - Fleet ID
  - Water in Fuel (if equipped)
- Diagnostics
  - Fault Diagnostics
  - Cluster Self Test
  - Part Number

## 58 Driver Information Display

---

- Vehicle Data (Volvo Engines Only)
  - Oil Level
  - Maintenance Data
- Data Log
  - Vehicle ID
  - Sweet Spot Data
  - Total Data
  - Trip Data
  - Reset Trip Data
- Tire Pressure System
  - Tire Pressure
  - Tire Temperature
- Password
  - Enter Password

Display Setting

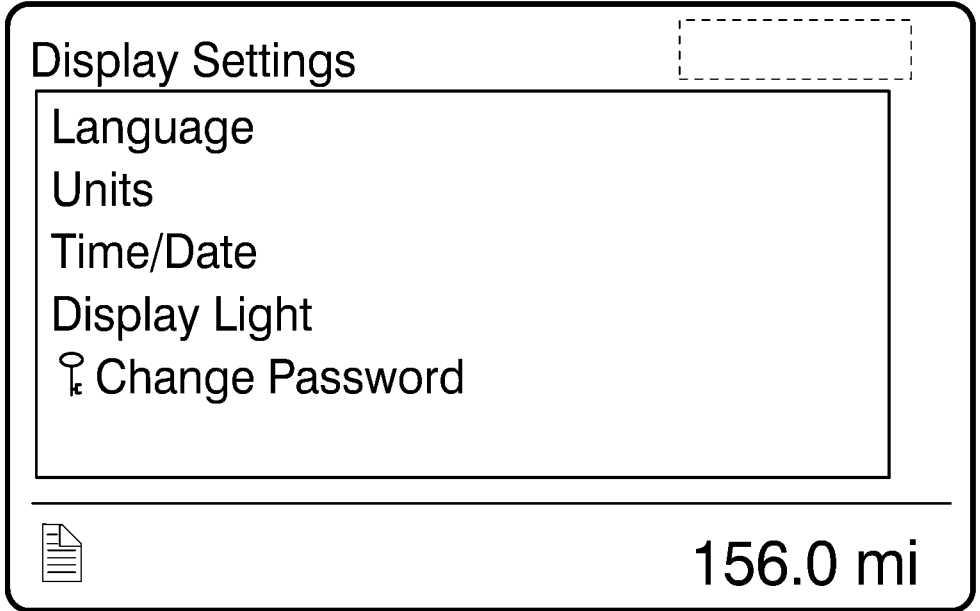

## 60 Driver Information Display

---

The Display Setting menu is used to change languages and units. The password, time and date can also be changed. The backlight and contrast of the display screen can be adjusted.

- Language
- Units
- Time/Date
- Display/Adjust
- Change Password

### 1. Language

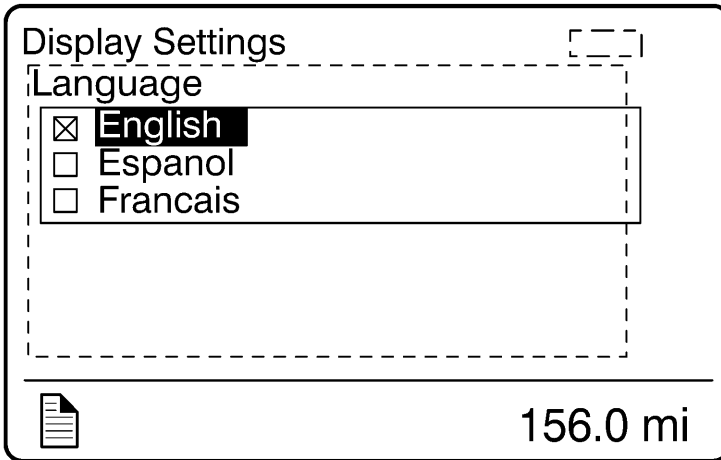

## 2. Units

- Distance
- Fuel Consumption
- Temperature

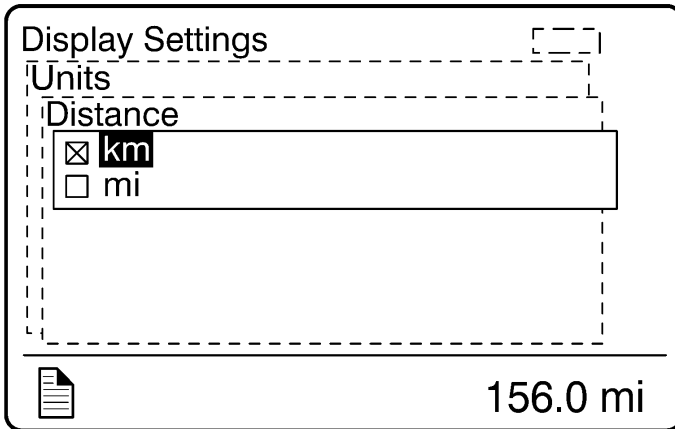

Distance

W3007395

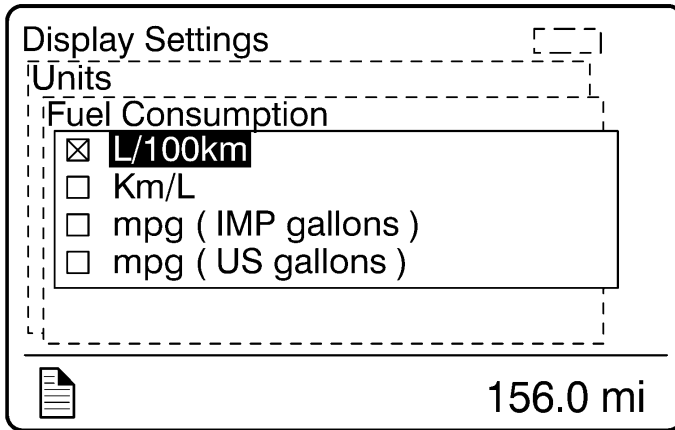

W3007394

Fuel Consumption

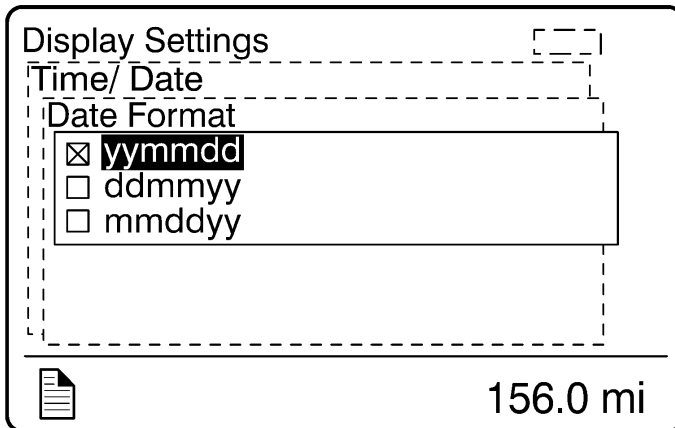

W3007391

Date Format

## 4. Display Light

The Display Light menu has three sub-menus:

- Contrast
- Backlight
- Night/Day

Use the Night/Day menu to choose a dark background with light text and images or a light background with dark text and images.

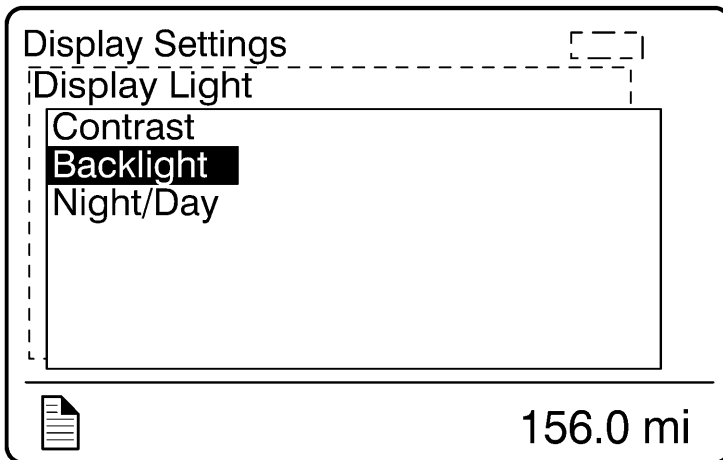

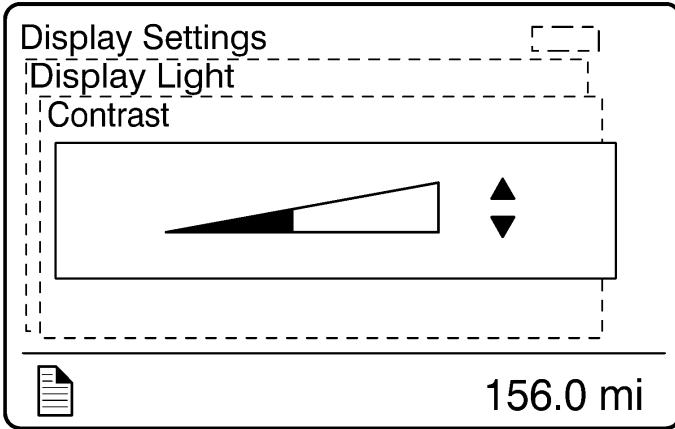

W3007389

Contrast

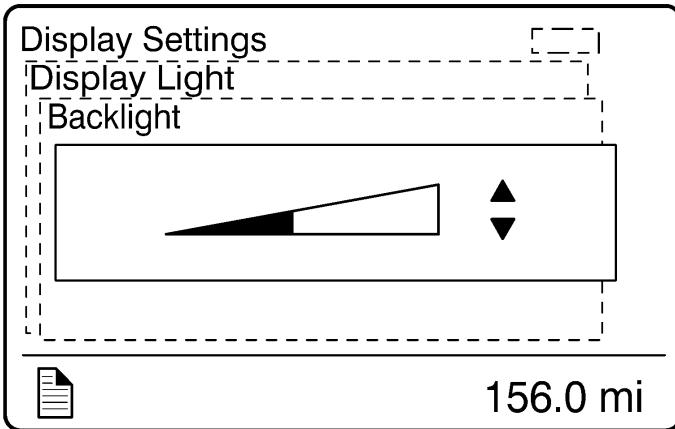

W3007388

Backlight



## 5. Change Password

**Note:** This menu is only accessible if the correct password is entered. The default password from Volvo is 0000.

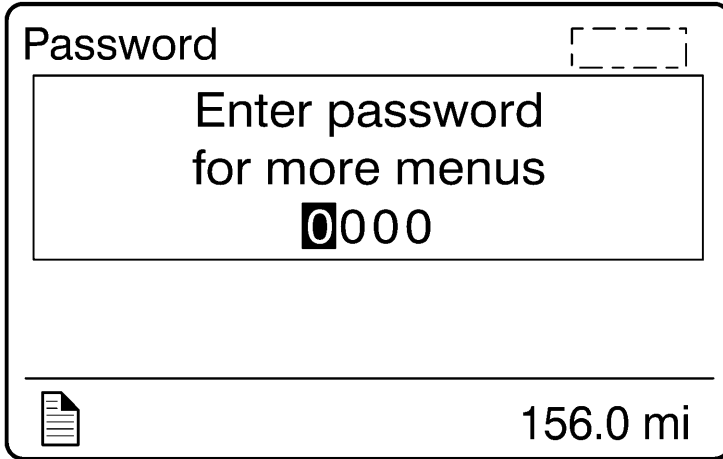

## Vehicle Settings

The Vehicle Settings menu allows fleet owners to set targets for vehicle operation regarding maximum engine speed, maximum road speed, and fuel consumption.

**Note:** This area is password protected.

### 1. Fleet Limits

The Fleet Limits menu has three sub-menus:

- RPM Limit
- Speed Limit
- Fuel Target





Vehicle Settings [ ]

Fleet Limits

Speed Limit

Present: 0 . 0 mph

Set new value: 000 . 0 mph

---

 156.0 mi

W3007384

Vehicle Settings [ ]

Fleet Limits

Fuel target

Present: 23 . 5 mpg

Set new value: 23 . 5 mpg

---

 156.0 mi

W3007383

## 2. Fleet ID

**Note:** This menu can only be accessed if the correct password has been entered.

The owner can enter the Fleet ID of the vehicle in this menu if required. Data registered in the engine control unit is then registered for this ID. Enter the new Fleet ID using the up and down arrows. Enter one number at a time followed by pressing the Enter button. 13 characters must be entered, blank characters are entered in unused positions. The ignition key must be turned off and back on to update the fleet ID.

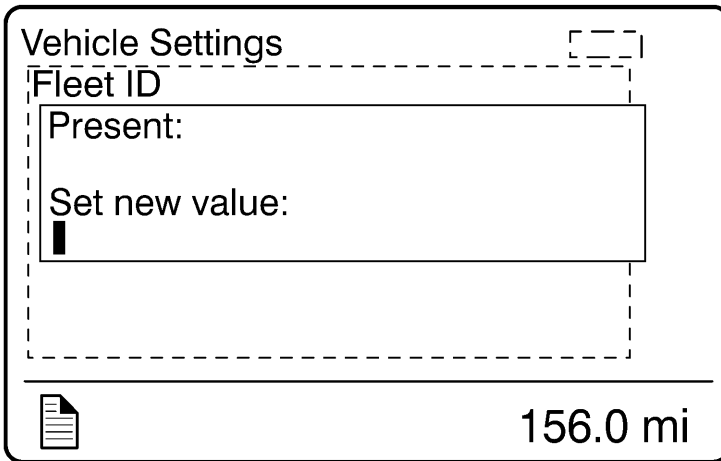

### 3. Drain Water in Fuel (if equipped)

Press the Enter button to request drain the water in the fuel.

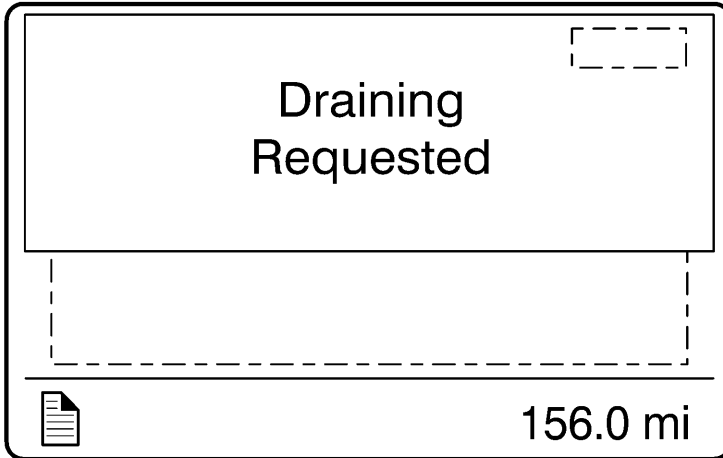

W3007381

### Diagnostics

The Diagnostics menu enables fault tracing on the control units in the vehicle to check for faults. Instrument tests are available to check the telltales, gauges, display and speaker. The part number of a control unit can be identified in the part number menu.

### 1. Fault Diagnostics

A list of the control units on the vehicle is displayed in the Fault Diagnostics menu.

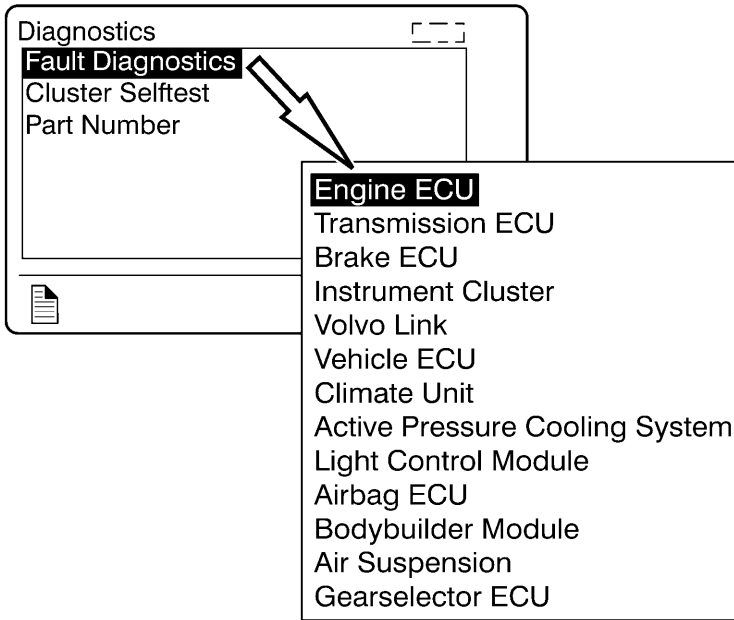

W3007380

### 2. Cluster Self Test

There are four sub-menus available:

- Telltales test
- Gauge test
- Display test
- Speaker test





The following table describes the tests. To cancel a test, press the Esc button.

<b>Telltale Test</b>	Telltale illuminate for approximately five seconds.
<b>Gauge Test</b>	The indicators move forwards and backwards between the end positions. They do not show any particular value. This is just a check to confirm that the indicators move, and to make sure the operators are working.
<b>Display Test</b>	The entire display lights up until the Esc button is pressed.
<b>Speaker Test</b>	The sound is activated and at the same time, the name of the selected sound is shown in the DID screen.

### 3. Part Number

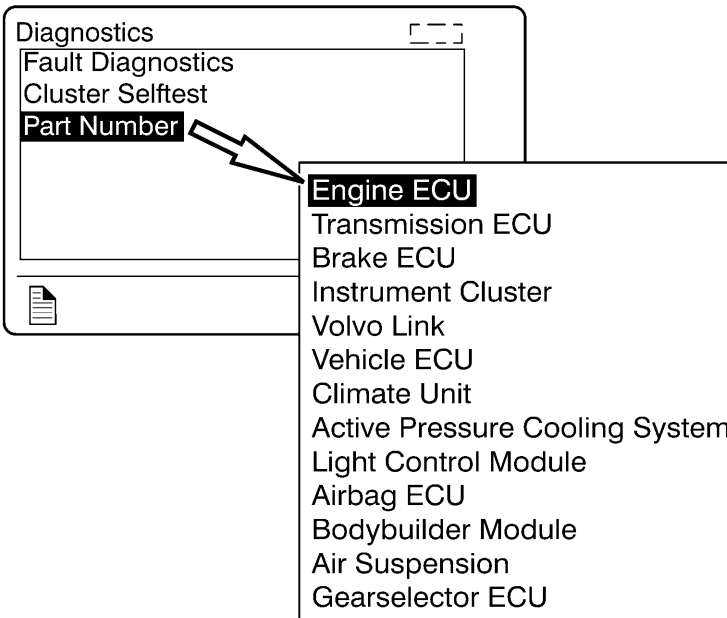
A list of the control units on the vehicle is displayed in the Part Number menu.



Diagnostics 

Part Number

Data Transfer  
In Progress  
Please Wait

---

 156.0 mi

W3007378

Diagnostics 

Part Number

Airbag ECU

Hardware number:  
VOLVO\*20452786P01  
00000409  
Software number:  
20452787P01  
20452780 P0120452783 P01

---

 156.0 mi

W3007377

Diagnostics

Part Number

Hardware Number:  
No data

Software Number:  
No data

---

 156.0 mi

W3007376

General Diagnostic  
Communication Error

# 76 Driver Information Display

---

## Vehicle Data

The engine oil level and Maintenance Data can be checked in the Vehicle Data menu.

### 1. Oil Level (Volvo engines only)

**Note:** For information about engine oil, refer to the Operator's Manual Vehicle Maintenance.

The vehicle is equipped with an electronic oil level sensor. The bar marked MIN and MAX shows the engine oil level. The number in the middle indicates the difference between the MIN and MAX level.

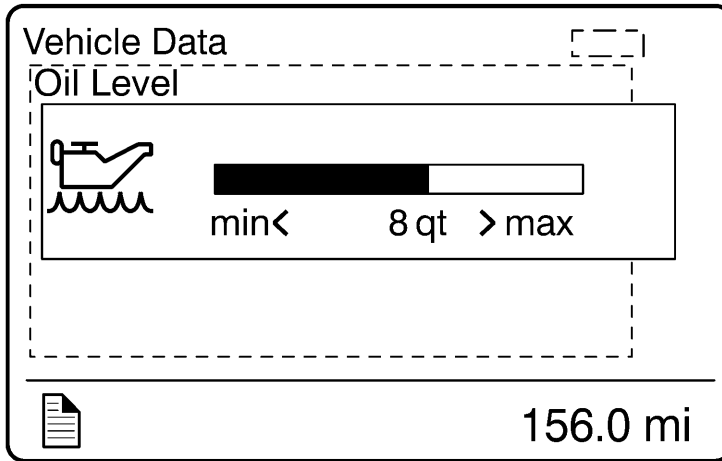

## 2. Maintenance Data

Vehicle Data

Maintenance Data

- Engine Oil / Filter Change
- Air Filter Change
- Coolant Change
- Transmission Oil Change
- Engine Oil Change

 156.0 mi

# 78 Driver Information Display

---

## Datalog

### 1. Vehicle ID

Datalog

Vehicle ID

Fleet ID:

0000000

Chassis ID:

0000000

---

 156.0 mi

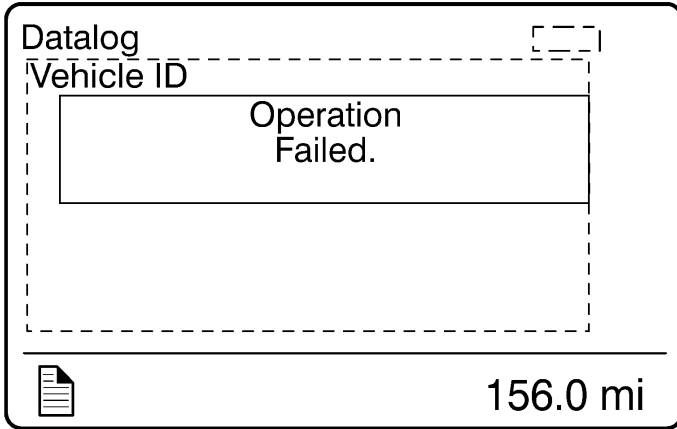

W3007373

Communication Error

## 2. Sweet Spot Data

**Note:** For information about sweet spot data, refer to Performance Bonus Guide in the vehicle operator's manual.

The image shows a screenshot of a vehicle's Driver Information Display (DID) with a black border. At the top left, the word "Datalog" is displayed. Below it, "Sweet Spot Data" is shown. A dashed-line box highlights the "Sweet Spot % Fuel:" section, which contains two lines of data: "Trip Data 64%" and "Total Data 64%". At the bottom left, there is a small icon of a document with lines representing text. At the bottom right, the text "156.0 mi" is displayed.

Category	Value
Sweet Spot % Fuel (Trip Data)	64%
Sweet Spot % Fuel (Total Data)	64%



### 3. Total Data

Totals indicate the accumulated engine values that have been logged during the lifetime of the engine ECU. Six different totals are stored.

Datalog 

Total Data

Total distance:  
136.3 mi

Total fuel used:  
24.2 g

---

 156.0 mi

W3007370

Datalog 

Total Data

Total engine hours:  
7.4 hours

Total idle time:  
2.7 hours

---

 156.0 mi

W3007369

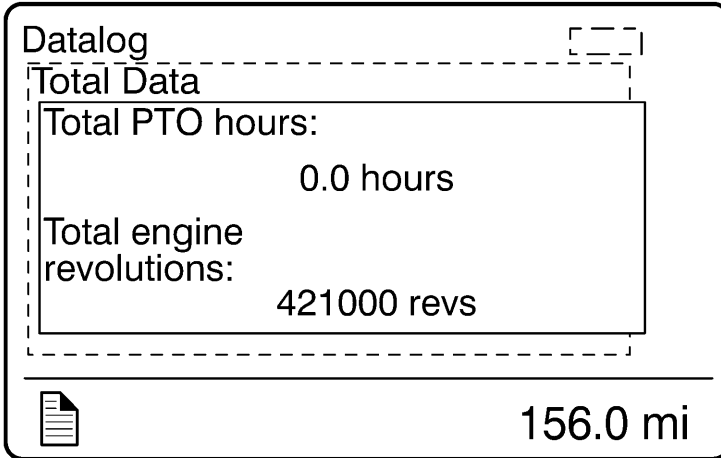

W3007368

### 4. Trip Data

**Note:** Some menus are not available with the Cummins ISX engine.

There are 14 different trip data values stored.

**Note:** The trip data must be reset before each measurement, see “5. Reset Trip Data” page 87.

Datalog 

Trip Data

Trip distance:  
136.3 mi

Trip fuel avg:  
5.6 mpg

---

 156.0 mi

W3007367

Datalog 

Trip Data

Trip fuel acc:  
24.1 g

Trip cruise:  
0.6 hours

---

 156.0 mi

W3007366

Datalog 

Trip Data

Trip  
uneconomy rev's:  
0.3 hours

Trip overrev's:  
7.4 hours

---

 156.0 mi

W3007365

Datalog 

Trip Data

Trip fuel  
uneconomy rev's:  
2.7 g

Trip average speed:  
18.5 mph

---

 156.0 mi

W3007364

Datalog 

Trip Data

Trip overspeed:  
3.9 hours

Trip engine hours:  
7.4 hours

---

 156.0 mi

W3007363

Datalog 

Trip Data

Trip idle time:  
2.7 hours

Trip idle fuel:  
4.5 g

---

 156.0 mi

W3007362

Datalog

Trip Data

Trip PTO hours: 0.0 hours

Trip PTO fuel: 0.0 g

---

 156.0 mi

### 5. Reset Trip Data

**Note:** This menu can only be accessed if the correct password has been entered.

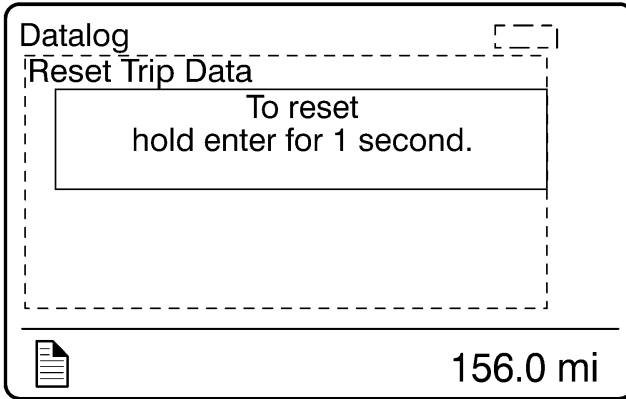

W3007360

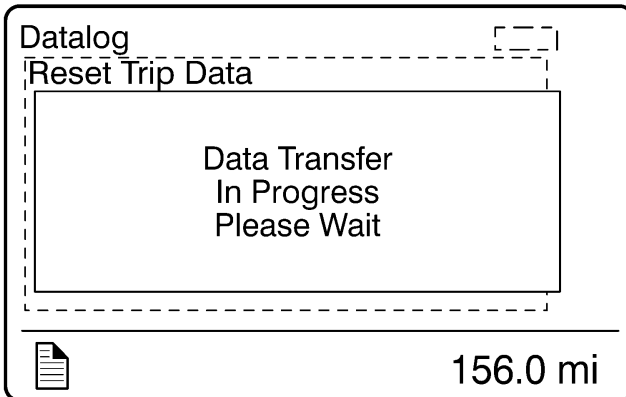

W3007359

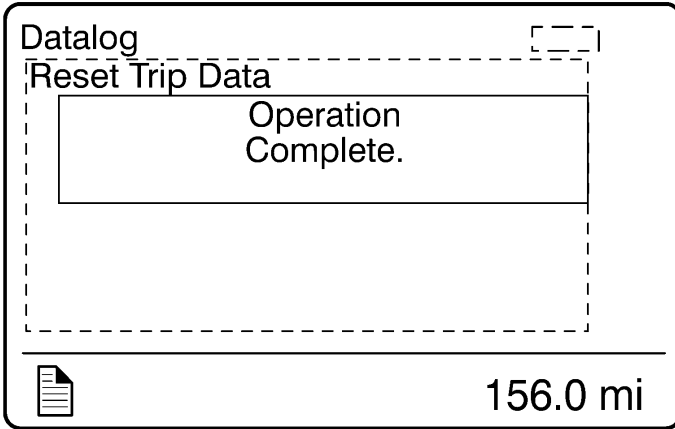

W3007358

Successful Reset

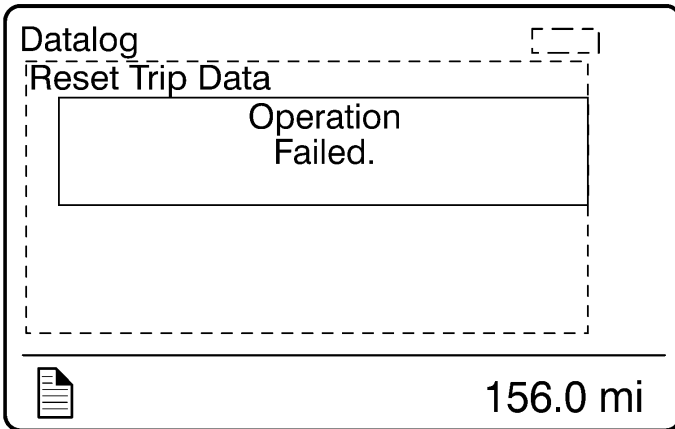

W3007357

Unsuccessful Reset



## **Pre-Trip Assistance**

The Pre-Trip Assistance option is a tool to assist the driver in completing the pre-trip inspection of the vehicle. This option is not a substitute for a complete pre-trip inspection. If any system of the vehicle does not pass inspection, the error must be corrected before operating the vehicle.

The available pre-trip tests include a Switch/Circuit Status check, Exterior Light Inspection check, and a Air Leakage check.

## Switch/Circuit Status Check

The Switch/Circuit Status check tests the functionality of the switches and their corresponding circuits. To start the check the driver must turn the individual switches on/off. As the switches turn on/off, the cluster updates the DID to show switch option being tested and it's status.

**Note:** The Hazard and High/Low Switches are momentary switches and return to the OFF position when released during testing.

1. The initial Pre-Trip screen displays. Using the stalk controls, select Switch Status.



W3030322

2. After the diagnostic is completed, the following screen displays detailing the status of each switch.

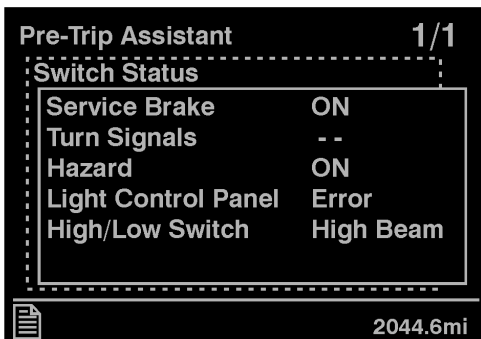

W3030323

## Exterior Light Inspection Check

The Exterior Light Inspection check repeatedly turns all exterior lights on/off for the vehicle. This allows the operator to start the test, exit the vehicle and do a visual check that all exterior lighting is functioning properly.

The following exterior lights are cycled through the check:

- Parking
- Hazard
- Turn signals (left and right)
- High/Low beam headlights
- Brake
- Fog/Driving (Optional)

1. From the Pre-Trip Assistant main screen select Exterior Light Inspection.



## 92 Driver Information Display

---

2. The Test Started screen displays. You can stop the test by pressing 'ESC' on the stalk or by starting the ignition.

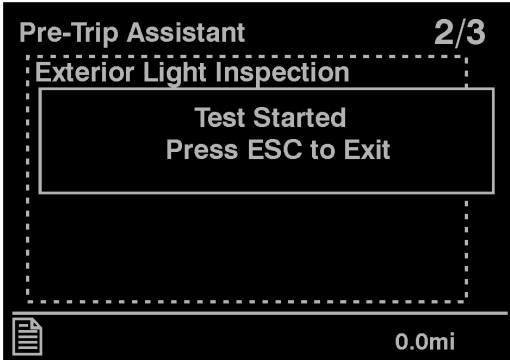

W3030325

Once the test is started all exterior lights flash on and off so that you can perform a visual check.

## Air Leakage Check

The Air Leakage check allows the driver to accurately measure the amount of air pressure drop in the front and rear brake air systems. After selecting this test from the DID, you are prompted to apply the service brake for 60 seconds. After applying and holding the service brake for 60 seconds, the DID will display the amount of pressure drop in the brake system. Before starting the test through the DID, complete the following:

- Start the engine and check that the brake pressure gauges are greater than 136 Nm (100 psi).
  - Turn engine off.
  - Release all brakes and allow the system to settle (air gauge needle stops moving).
1. When running the brake pressure test the following screen displays. Press and hold the brake pedal for a total of 60 seconds.

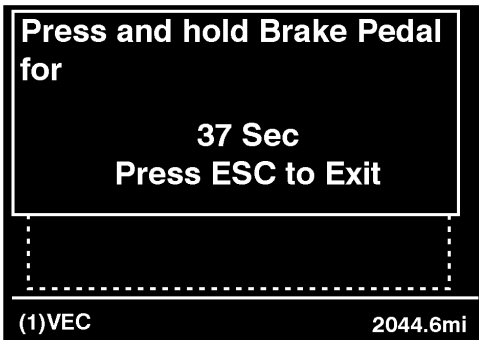

W3030047

If the air tanks are not full, in order to complete the air leakage test, the following screen displays.

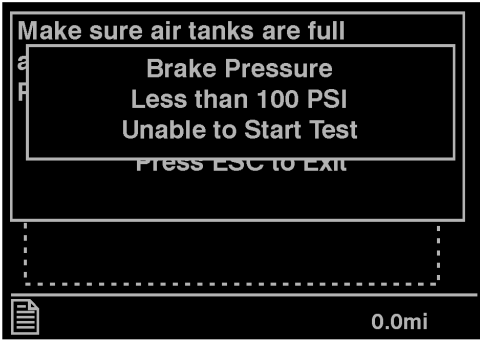

W3030327

2. When the system is ready to be checked, the following screen displays. Press Enter to begin the test.

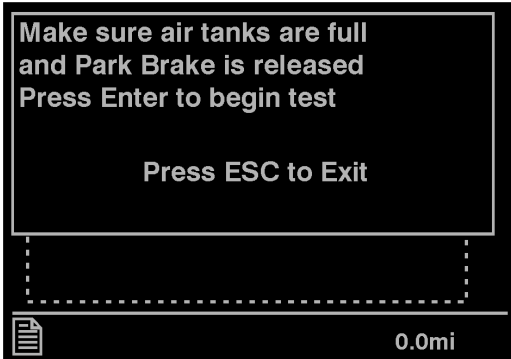

W3030328

Press and hold the brake pedal for 60 seconds. If the brake pedal is not pressed and held for 60 seconds the following warning screen displays.

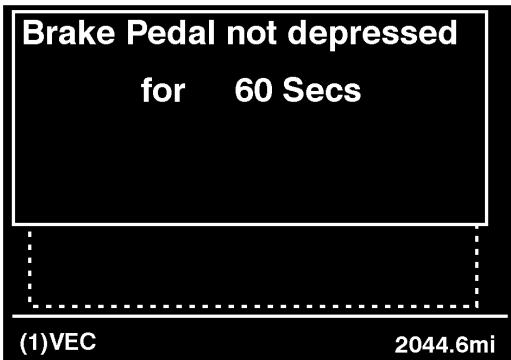

W3030049

3. Once the brake pressure test is completed the pressure leak test results are displayed.

<b>Pressure Leak Test Results</b>			
<b>Tank</b>	<b>Before</b>	<b>After</b>	<b>Drop</b>
<b>F</b>	<b>127</b>	<b>127</b>	<b>0</b>
<b>R</b>	<b>129</b>	<b>129</b>	<b>0</b>

(1)VEC 2044.6mi



## Volvo Enhanced Cruise (VEC)

The Volvo Enhanced Cruise (VEC) reacts to vehicles moving in the same direction as your vehicle. The system is not responsive to stopped vehicles, side-to-side moving traffic, or oncoming traffic. The system will not slow your vehicle or provide warning as you approach vehicles in these circumstances.

If the vehicle is equipped with the adaptive control and is activated, several screens are displayed through the DID. For additional information on the Volvo Enhanced Cruise adaptive cruise control, refer to the Volvo Enhanced Cruise ACB (Active Cruise with Braking) service manual.

1. Distance Alert: When a vehicle moving in the same direction as your vehicle and is within the alert distance the following screen displays.

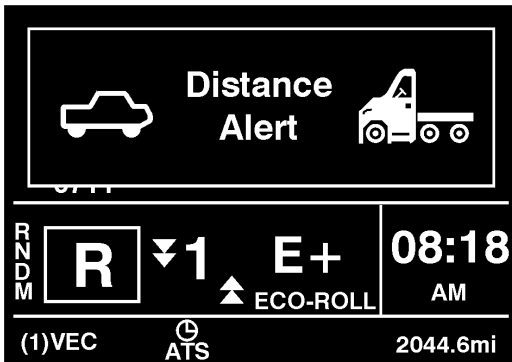

## 98 Driver Information Display

---

2. Time Gap: After the Distance Alert screen displays, several time gap screens display, relaying the total time distance between your vehicle and the vehicle in front of you. The minimum time gap between your vehicle and vehicle ahead is 1.5 seconds. The maximum is 3.5 seconds.

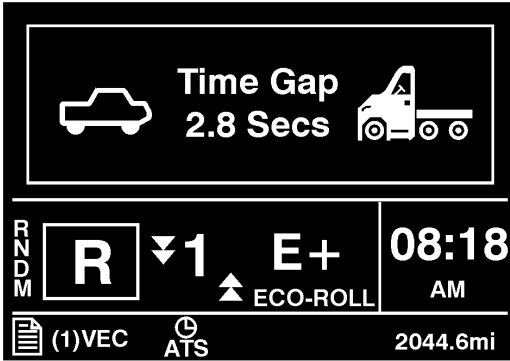

W3030069

3. If the VEC detects that the vehicle is within a certain distance that a vehicle collision is eminent, driver intervention is required. The following screen displays.

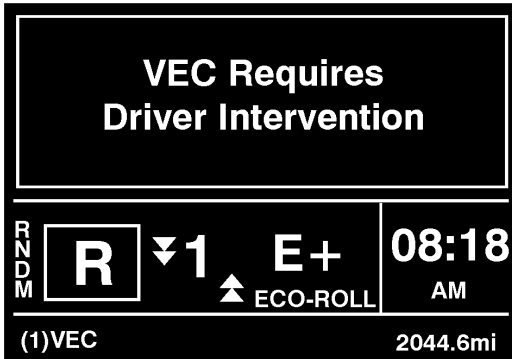

W3030066

4. When the vehicles are within collision distance, the following screen displays.

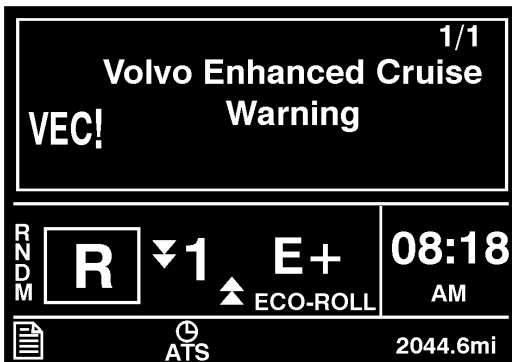

W3030067

# 100 Driver Information Display

---

5. If the VEC system becomes temporarily unavailable the following screen displays.

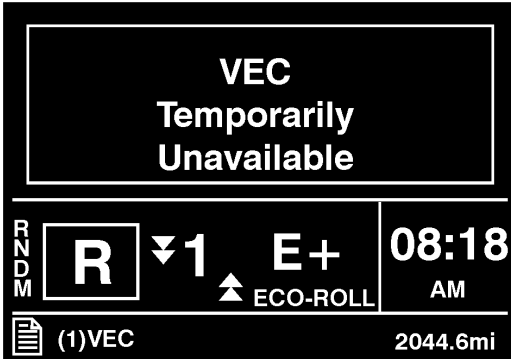

W3030070

6. When the VEC system is restored to proper operation the following screen displays.

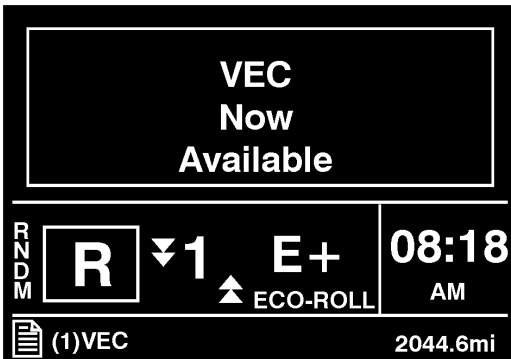

W3030072

## Tire Pressure System

### 1. Tire Pressure

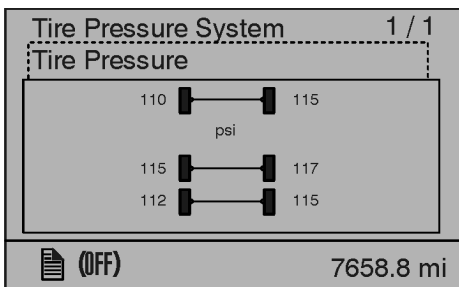

W7001465

## Password

Certain functions are password-protected and there are a number of passwords for the display. It is also possible to disable the password protection for functions, which is useful when the owner is the operator. Contact your local Volvo dealer to set this function.

### 1. Password

**Note:** This password must be changed to prevent unauthorized access to the menus.

These passwords give the user access to all password-protected functions. See "5. Change Password" page 65 to change the password.

The following menus are password-protected and marked with a key symbol in the menus:

- Fleet Limits
- Fleet ID
- Reset (applies to a number of functions)

## 102 Driver Information Display

---

When the ignition key has been in the stop position for more than 60 seconds or the batteries have been disconnected, the password must be entered again in order to access all the functions.

No functions should be password-protected:

To make all menus available without password you must go to Password and press the Enter button.

You can also go to a password-protected menu and press the Enter button. A password entry box is displayed.

- 1 Select the Password menu.
- 2 The password consists of a four-digit number, 0000?9999, that is scrolled forward using the up and down arrows on the control lever, one number at a time, followed by pressing the Enter button. The display shows the following:  
Press the Enter button when the correct password has been entered.

**Note:** If the ignition key has been in the stop position for more than 60seconds or the batteries have been disconnected, the password must be entered again in order to access all the functions.

- 3 If an incorrect password is entered, the user is returned to point 2. Re-enter the password using the up and down arrows, followed by the Enter button on the control stalk as in point 2.

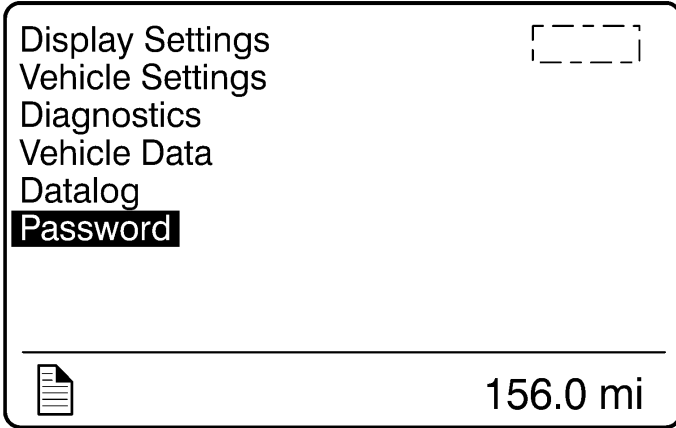



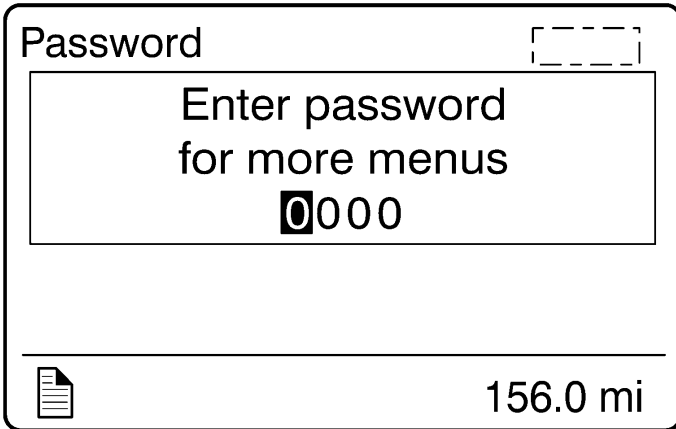









W3007371















W3007356

## DISPLAY SYMBOLS











### Alarm, Check and Information Symbols













Symbol	Meaning
 <small>T3014529</small>	Coolant temperature
 <small>T3008851</small>	Coolant level
 <small>T3014506</small>	Engine oil pressure
 <small>T3014525</small>	Engine Oil level
 <small>W3005104</small>	Engine oil temperature
 <small>T3014511</small>	High engine oil temperature
 <small>T3016138</small>	Fault in preheating
 <small>T3014455</small>	Engine temperature too low for engine brake (VEB)
 <small>W3005088</small>	Air filter restriction
 <small>T3014503</small>	Engine idle shut down
 <small>T3016140</small>	Transmission oil temperature
 <small>W3005098</small>	High transmission oil temperature









Symbol	Meaning
 <p style="text-align: right; font-size: small;">T3014507</p>	Transmission malfunction
 <p style="text-align: right; font-size: small;">T3014494</p>	Low brake pressure or ABS
 <p style="text-align: right; font-size: small;">W3005087</p>	Air dump
 <p style="text-align: right; font-size: small;">W3005089</p>	Air suspension pressure
 <p style="text-align: right; font-size: small;">W3005090</p>	Air suspension pressure warning
 <p style="text-align: right; font-size: small;">T3014400</p>	Wheel spin
 <p style="text-align: right; font-size: small;">T3014424</p>	Anti-spin temporarily disengaged
 <p style="text-align: right; font-size: small;">W3005102</p>	5th wheel unlocked
 <p style="text-align: right; font-size: small;">W3005171</p>	Stop
 <p style="text-align: right; font-size: small;">W3005105</p>	Voltage meter
 <p style="text-align: right; font-size: small;">T3014509</p>	Voltage warning
 <p style="text-align: right; font-size: small;">T3008842</p>	SRS

# 106 Driver Information Display

Symbol	Meaning
 <p>T3008838</p>	Low level washer fluid
 <p>W3006084</p>	Fault in main beam
 <p>T3014470</p>	Interaxle lock
 <p>W3006119</p>	Differential lock
 <p>T3015664</p>	Fault in brake light
 <p>T3015663</p>	Fault in blinkers
 <p>T3014395</p>	Caution, freezing conditions
 <p>T3014505</p>	Fuel level
 <p>W3005101</p>	Outside temperature
 <p>W3005092</p>	Air application
 <p>T3014476</p>	Parking Brake engaged











Symbol	Meaning
 W3005366	Axle Temperature
 T3014527	Engine speed
 W3005083	Intake manifold pressure
 T3014518	Instantaneous/average fuel economy (liters/100km)
 T3014519	Instantaneous/average fuel economy (km/liter)
 T3014520	Instantaneous/average fuel economy (mpg)
 T3014521	Instantaneous/average fuel economy (liters/hour)
 W3005095	Leg fuel (liter)
 W3005091	Leg fuel (gallon)
 W3005096	Trip data (km)
 W3005097	Trip data (miles)
 W3005099	Average speed (km/h)
 T3014517	Average speed (mph)

# 108 Driver Information Display

Symbol	Meaning
 W3005094	Estimated time of arrival
 W3006078	Safety Belts Reminder
 W3029774	Performance Bonus Guide
 W3004309	Water in fuel
 W3007445	Aftertreatment Regeneration
 W3007444	High Exhaust System Temperature

## STATUS SYMBOLS

Status symbols are displayed at the bottom of the Mid Level and High Level instrument cluster DID screens.

Symbol	Meaning
 T3008841	Preheating active or preheating fault
 T3013619	Alarm clock activated
 T3013629	Message active
MI	Odometer, miles
KM	Odometer, kilometers
PTO	Power take-off active
CC	Cruise Control active
{1} T3014410	Engine brake position 1
{2} W3006122	Engine brake position 2
{6} W3005543	Engine brake position 6
 W3005100	Axle suspension pressure, front
 W3005084	Axle suspension pressure, rear
 W3005086	Distance to empty
 W3005148	ABS malfunction trailer
 W3005149	ABS malfunction tractor
 T3019229	Water in fuel priming
 W3029783	Water in fuel draining

## Other Symbols

There are various other symbols for the other menus which are not explained here. Refer to the sections on the different menus for explanations of those symbols.

## MESSAGES

### General

There are three types of messages:

- Stop
- Warning
- Information

Stop, warning, and information messages are displayed automatically with their associated symbols. Above the display are three lamps (for stop warning, or information messages) used to draw the attention of the operator whenever necessary. If the engine is running when a stop message comes on, a buzzer is also activated.

More than one message can be active at the same time. A displayed message can be replaced by a new message provided the new message has a higher priority. For example, the displayed message is the highest priority.

Only fault codes that have a direct impact on vehicle operation are displayed. All fault codes are stored in the appropriate ECU for access by service technicians.

### Stop Message

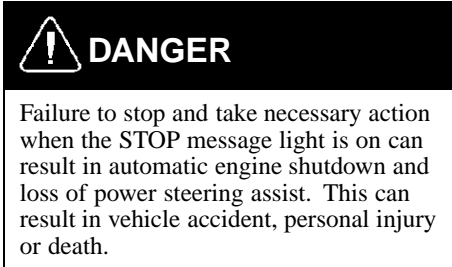

In the event of a serious fault, the red STOP light comes on; the buzzer will also activate if the engine is on. An illuminated STOP message light signifies a serious problem has been detected, and the operator must respond immediately to the problem.



W3005171

This lamp ON means the vehicle must be safely pulled off the road and stopped. In some instances, the engine must be switched off immediately.

In some cases preventive action may be taken by the engine ECU to protect the engine.

Example 1: if oil pressure or coolant level drops too low, the engine is forced to low idle and when the vehicle speed is zero, the engine shuts down.

Example 2: with excessive coolant temperature, the engine will gradually reduce power output to 50%. This telltale always activates the buzzer.

The engine may be restarted after the key is turned off and then back on. However, it will only operate for 30 seconds unless the problem is resolved.

The engine could be forced to low idle within 30 seconds from when the light comes on. Pull off the road as soon as possible without creating a safety hazard.



## CAUTION

If an engine problem is allowed to persist, serious damage to the engine may occur. Always repair the cause of the problem before operating the vehicle again.

See “Stop, Check, Info Symbols and Associated Icons” page 114 for other telltales that trigger the STOP message light.

## Warning Message



## DANGER

The CHECK warning message lights up when there is a specified fault the operator should be aware of. Air pressure is low and remaining air volume may not be sufficient for repeated braking. The emergency brakes may engage, causing a wheel lockup, loss of vehicle control. This can cause the vehicle to become a hazard to vehicles behind it. Bring the vehicle to a controlled stop. Failure to follow these precautions can result in loss of braking control, serious personal injury, vehicle accident or death.



**Note:** This lamp ON means that there is a specified fault that must be checked at the next stop.



W3005170

If there is an electrical or mechanical problem, the CHECK warning light comes on and a default message appears in the DID.

See “Stop, Check, Info Symbols and Associated Icons” page 114 for other telltales that trigger the CHECK warning light.

## Information Message

**Note:** This indicator light ON means there is a new information message.























W3005150





The INFO indicator light comes on when there is a new information message or an abnormal status is detected by the electronic control unit. A telltale, text or both are shown in the DID in addition to the INFO light. For certain telltales, a reference value is also shown.

**Note:** Make sure the indicated fault is checked at the next stop once the INFO indicator come on.

See “Stop, Check, Info Symbols and Associated Icons” page 114 for other telltales that trigger the INFO indicator.

## Stop, Check, Info Symbols and Associated Icons

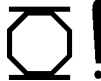
Symbols and Associated Icons		
 W3005171	 W3005170	 W3005150
Icons Displayed		
 T3014511	 W3005105	 T3008838
 W3005098	 W3006084	 W3005171
 T3014507	 T3015664	
 T3014494	 T3015663	
 W3005087	 T3014395	
 W3005102	 T3014505	
	 W3005092	
	 r/min T3014527	
	 W3005083	

	 <p>T3016138</p>	
	 <p>T3014455</p>	
	 <p>W3005088</p>	
	 <p>W3005090</p>	
	 <p>T3008842</p>	

## Acknowledging Messages

A fault message is acknowledged by pressing the Esc button after which the display returns to the same status that existed before the fault occurred. All messages can be acknowledged. Acknowledged but inactive messages are displayed again when the ignition key is turned to the START position or they can be read in the menu.

**Information or Warning Messages:** Information and warning messages can be acknowledged using the "Esc" button. This warning stays acknowledged until the next time the ignition key is turned to the START position.

**Exceptions:** The message can be displayed again if the fault is corrected and then becomes active again.

**Example:** If the transmission fluid temperature is too high, a message will be activated automatically. The operator acknowledges this message using the Esc button. If the temperature then drops to a normal level temporarily and then increases again to an excessive level, the warning will activate again.

**Stop Message:** The buzzer and a STOP message can be acknowledged using the Esc button, but may become active again 10seconds after the last acknowledgment. The STOP symbol will be illuminated the whole time.

## Examples of Fault Symbols and Text

### Factory — Installed Equipment When Stationary

The stop, warning, or info symbol comes on and the information message is shown on the display (for more information on the fault, see “1. Fault Diagnostics” page 72). A warning tone will be heard if the engine is running when a stop message is activated. The message contains information about the location of the fault where the fault has occurred:

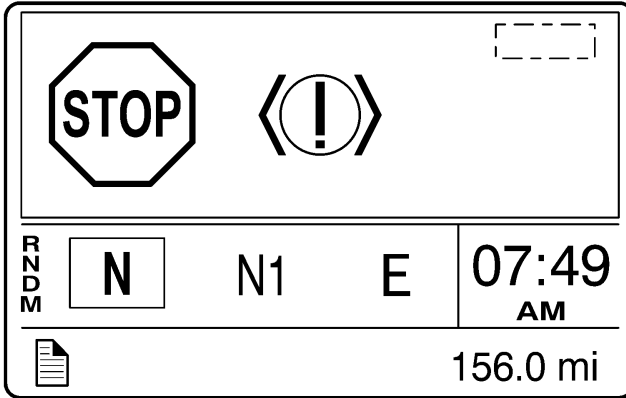

W3007349

### Non-Factory-Installed Equipment

If a coach builder or customer has retrofitted equipment that is connected to the data link, the following symbols may be displayed:

MID (Message Identifier) = control unit

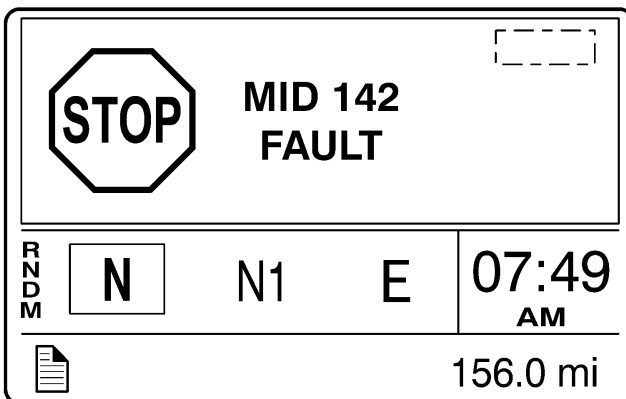

W3007350

# 118 Driver Information Display

---

## Examples of Symbol and Value

Information, warning or stop symbol comes on and another symbol and value is displayed.

Example of warning message:

## Warning, Freezing Conditions

The Freezing conditions message is activated when the outside temperature drops below  $2^{\circ}\text{C}$  ( $35^{\circ}\text{F}$ ) or increases from a lower temperature to  $-2^{\circ}\text{C}$  ( $28^{\circ}\text{F}$ ). Press the Esc button to acknowledge the warning. The warning is cancelled when the temperature drops below  $-3^{\circ}\text{C}$  ( $26^{\circ}\text{F}$ ) or rises to  $3^{\circ}\text{C}$  ( $37^{\circ}\text{F}$ ).

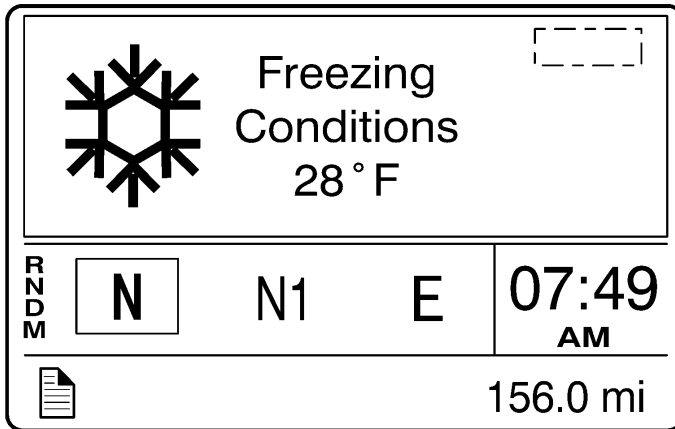



# **VOLVO**

**Volvo Trucks North America**

P.O. Box 26115 Greensboro, NC 27402-6115

**Volvo Trucks Canada, Ltd.**

5600A Cancross Court, Mississauga, Ontario L5R 3E9

<http://www.volvotrucks.volvo.com>